

# ELITE DECOR

## BALTO GIPSO LIPDINIAI IŠ ITALIJOS



Balto gipso dekoratyviniai lipdiniai, dekoras interjero apdailai.

UAB "KUBĖ" įmonės kodas 304850419; PVM kodas LT100011680918

Laisvės pr. 82, Vilnius, Lietuva; tel: +37061270035; info@elitedecor.lt; lipdiniai@gmail.com

[www.EliteDecor.lt](http://www.EliteDecor.lt)  
stucchi artistici decorativi  
artistic stuccoworks  
**jagorovai**

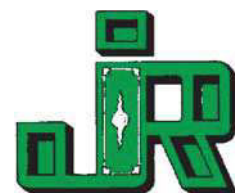





articolo  
article  
style  
artikel  
artikel

lunghezza barre/length bars/morceau barres/Dauer pegelanzeige 150 cm \* 120 cm

cm

angoli • centine • mezzerie

JUOSTOS, APVADAI, MOLDINGAI, PILNAVIDURIAI KARNIZAI

3019		0,7   1,6			6017
41/B		0,9   2,4	85	96	
3077		2,0   2,0			
700		1,1   2,0	424	443	425
285		0,8   2,1	401	404	
62/B		1,1   2,2	118 403	93	
735		1,2   2,2		839	
52/B		1,5   2,3	92	234	
791		1,7   2,3			
41/C		1,1   2,4	136 137	121	
* 616	1,2 M ILGIO JUOSTA 	1,2   2,6	850		
46/D		1,2   2,6	81	414	
720		1,5   2,6	828	819	
3029		1,8   2,6			
293		1,9   2,6			



















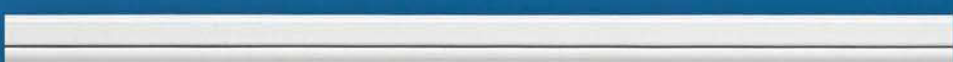









# CORNICI • moulures • cornices • leisten • lijsten

articolo  
article  
style  
artikel  
artikel

lunghezza barre/bar length/longueur barres/länge der Leisten 150 cm

cm

angoli • centine • mezzerie

291 291			0,9 2,8	409 421	408
306/D 306/D			1,0 2,8	61A	804
299 299			1,7 2,8	827	417
20/D 20/D			1,1 2,9	822	269
753 753			1,2 3,0		6012
288 288			1,3 3,1		406
61/B 61/B			1,4 3,0	260 91	233
789 789			1,4 3,0		
3018 3018			1,8 3,0		
36/B 36/B			1,1 3,1	872 261	871 97
721 721			1,9 3,5	851	820
49/B 49/B			1,7 3,2	74 214	849 215
60/B 60/B			1,9 3,2		
23/C 23/C			1,3 3,3	134	94 430











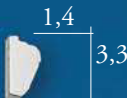

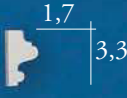

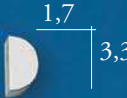

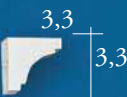

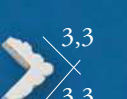

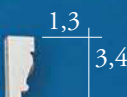

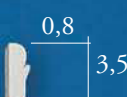

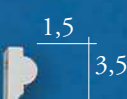

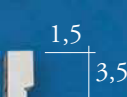

articolo  
article  
style  
artikel  
artikel

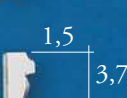
lunghezza barre/bar length/longueur barres/länge der Leisten 150 cm

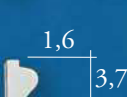
angoli • centine • mezzerie

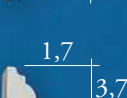
cm

702 702			432	846	
28/C 28/C			883		6008
46/B 46/B				6015	
289 289					
3013 3013					
277 277			6009	407	
255 255			135	257	
779 779				6018	
790 790					
740 740			6026	840	6027
24/B 24/B			88	230	
68/B 68/B			259	267	802 226
38/B 38/B			70	413	
284 284			826	405	





























# CORNICI • moulures • cornices • leisten • lijsten

articolo  
article  
style  
artikel  
artikel

lunghezza barre/bar length/longueur barres/länge der Leisten 150 cm

cm

angoli • centine • mezzerie

292 292			3/A 411	410
35/B 35/B			824	95 825
27/B 27/B			98 99	232
65/B 65/B			220 225	222
704 704			13/A 823	813
737 737				
24/C 24/C				
23/B 23/B			89 90	876
754 754				6013
66/B 66/B			427 147	268
57/B 57/B				271
788 788				
48/A 48/A			84	231
707 707			442	845



articolo article style artikel artikel	lunghezza barre/bar length/longueur barres/länge der Leisten 150 cm	cm	angoli • centine • mezzerie		
758 758		2,1 4,3			
50/B 50/B		1,7 4,4	77	223	816
55/B 55/B		1,8 4,4		270	
283 283		4,1 4,2			
780 780		2,6 4,5			
3038 3038		2,8 4,5			
210 210		1,5 4,8	216	229	217
254 254		1,8 4,8			
63/B 63/B		2 4,8	869	235	
56/B 56/B		2,4 4,8			
706 706		2,2 4,9	441	844	
701 701		0,9 5	431		
3020 3020		1 5			
276 276		2 5	868	866	865

# CORNICI • moulures • cornices • leisten • lijsten

articolo  
article  
style  
artikel  
artikel













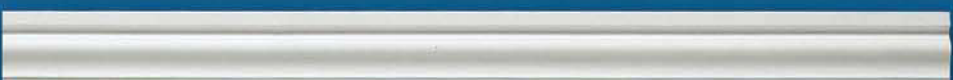

lunghezza barre/bar length/longueur barres/länge der Leisten 150 cm \* 200 cm

cm

angoli • centine • mezzerie

715 715			2 5	102L 6019
3022 3022			2 5	877 879 878 880
793 793			2,2 5	
211 211			2,3 5	6028 6023
3030 3030			2,5 5	
* 2017 2017 2,0 MILGIO			5 5	
208 208			1,8 5,1	206 205
777 777			1,2 5,2	
771 771			2,3 5,2	
3003 3003			2,4 5,2	6011 861
776 776			3,1 5,2	
49/C 49/C			2,3 5,4	
278 278			2,5 5,5	6021
772 772			1,8 5,5	



articolo article style artikel artikel	lunghezza barre/bar length/longueur barres/länge der Leisten 150 cm	cm	angoli • centine • mezzerie
209 209		2 5,5	212 213
49/A 49/A		3 5,5	
732 732		2 5,6	834 875 835 855 856
265 265		1,9 5,7	434 870
3002 3002		2 5,8	862 6010 860 863
21/C 21/C		2,5 5,8	852 853 854
3001 3001		2,2 5,9	857 858 859
787 787		2 6	6014
3024 3024		2,1 6	
794 794		3,2 6	
3037 3037		3,2 6	
3040 3040		3,6 6	
240 240		1,4 6,2	251 246 252
792 792		3 6,2	















CORNICI • moulures • cornices • leisten • lijsten

articolo  
article  
style  
artikel  
artikel

lunghezza barre/bar length/longueur barres/länge der Leisten 150 cm

cm

angoli • centine • mezzerie

290 290		1,5 6,3	418
37/B 37/B		2,8 6,3	
722 722		6,7 6,3	841
300 300		3,2 6,4	
253 253		1,3 6,7	6016
786 786		2,2 6,7	
3017 3017		1,7 6,9	6016
1/B 1/B		2,3 7	
310/D 310/D		2,3 7	6016
2/B 2/B		3,5 7	
53/B 53/B		3,3 7	6016
296 296		3 7	
3016 3016		2,1 7,2	6016
752 752		2,9 7,3	



articolo  
article  
style  
artikel  
artikel

lunghezza barre/bar length/longueur barres/länge der Leisten 150 cm

cm

angoli • centine • mezzerie

3007  
3007

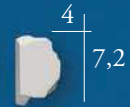

3041  
3041

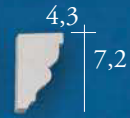

54/B  
54/B



64/B  
64/B

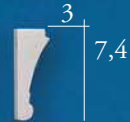

759  
759



727  
727

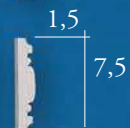

833 6020

798  
798



705  
705



847

3021  
3021

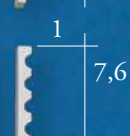

279  
279

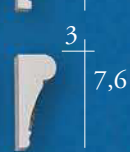

282  
282

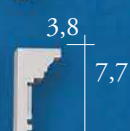

796  
796



784  
784



726  
726



# CORNICI • moulures • cornices • leisten • lijsten

articolo  
article  
style  
artikel  
artikel













lunghezza barre/bar length/longueur barres/länge der Leisten 150 cm \* 200 cm

cm

angoli • centine • mezzerie























262 262		1,5 8	
778 778		5,5 8	
708 708		3,6 8,5	
280 280		1,5 8,7	836
738 738		3,5 8,8	
768 768		3,5 9	
* 3009 3009	2,0M ILGIO JUOSTA 	3 9,2	882/S 882/D
* 3008 3008	2,0M ILGIO JUOSTA 	2 9,5	
709 709		3,7 9,5	
797 797		7,2 9,6	
3043 3043		1,2 9,9	
724 724		4,3 9,9	
* 3025 3025	2,0M ILGIO JUOSTA 	2,1 10	
795 795		3,7 10	



articolo article style artikel artikel	lunghezza barre/length bars/morceau barres/Dauer pegelanzeige 150 cm	cm	angoli • centine • mezzerie
3078		6,1	10,1
3079		5,5	10
766		6	10
3069		2,5	10
275		2,5	10,1
3012		4,3	10,1
3035		4,3	10,1
3036		4,3	10,1
3042		4	10,2
3053		1,5	12,1
723		4	11,4
3004		3,9	11,7

lunghezza barre/length bars/morceau barres/Dauer pegelanzeige 150 cm

cm angoli • centine • mezzerie





















747			6 12
767			7,7 12,3
3010			1,7 12,6
3005			7 13,1
703			3,7 13,5
3006			7,5 13,5
748			4,5 13,6
281			4,5 13,8
3032			5 14
3060			4 15,6
3051			8,4 18



lunghezza barre/length bars/morceau barres/Dauer pegelanzeige 150 cm \* 140 cm

cm angoli • centine • mezzerie

JUOSTOS, PILNAVIDURIAI KARNIZAI

782			6,5	19,3
3011			2,3	19,6
749			8,3	19,7
775			3,3	20,2
3058			2,1	19,3
3061			4,3	16
750			6,1	20,2
763			1,8	20,4
* 774 1,4 m ILIGIO JUOSTA			2	24,3
3068			9,8	28,1

articolo  
article  
style  
artikel  
artikel

lunghezza barre/length bars/morceau barres/Dauer pegelanzeige 150 cm

cm angoli • centine • mezzerie

LYGŪS PAGALBINIAI PRODILIAI

Pens 5



2  
5

Pens 10

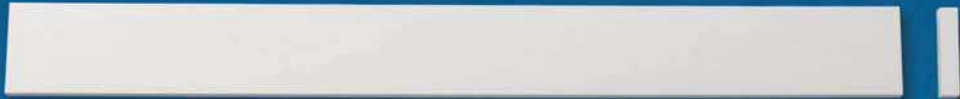

2  
10

Pens 14



2  
14,5

Pens 18

































2  
18

































LUBINIAI KARNIZAI



























203			$\begin{array}{l} \text{cm } 3 \\ 3 \diagdown 4 \end{array}$
741			$\begin{array}{l} \text{cm } 7,6 \\ 3,8 \diagdown 8,4 \end{array}$
3027			$\begin{array}{l} \text{cm } 6 \\ 4,8 \diagdown 7,5 \end{array}$
746			$\begin{array}{l} \text{cm } 5 \\ 5 \diagdown 6,8 \end{array}$
725			$\begin{array}{l} \text{cm } 5,2 \\ 5,5 \diagdown 7,2 \end{array}$
734			$\begin{array}{l} \text{cm } 3 \\ 5,4 \diagdown 6 \end{array}$
201			$\begin{array}{l} \text{cm } 6,3 \\ 5,8 \diagdown 8,4 \end{array}$
202			$\begin{array}{l} \text{cm } 6,3 \\ 5,8 \diagdown 8,4 \end{array}$
204			$\begin{array}{l} \text{cm } 6,3 \\ 5,8 \diagdown 8,4 \end{array}$
3023			$\begin{array}{l} \text{cm } 6,7 \\ 6,5 \diagdown 9 \end{array}$
298			$\begin{array}{l} \text{cm } 7,8 \\ 6,5 \diagdown 10 \end{array}$
761			$\begin{array}{l} \text{cm } 6,5 \\ 6,7 \diagdown 9,3 \end{array}$
3049			$\begin{array}{l} \text{cm } 5,1 \\ 5,1 \diagdown 6,7 \end{array}$
3050			$\begin{array}{l} \text{cm } 6 \\ 6 \diagdown 8,1 \end{array}$
717			$\begin{array}{l} \text{cm } 6,5 \\ 7,2 \diagdown 9,5 \end{array}$

SGUSCIONI • corniches • cover-angles • schalen • kooflijsten





















lunghezza barre/length bars/morceau barres/Dauer pegelanzeige 150 cm

298/B			$\begin{array}{l} \text{cm 7} \\ 7 \text{ --- } 9,7 \\ \diagup \end{array}$
742			$\begin{array}{l} \text{cm 5,6} \\ 7,1 \text{ --- } 8,8 \\ \diagup \end{array}$
770			$\begin{array}{l} \text{cm 6} \\ 7,5 \text{ --- } 9,5 \\ \diagup \end{array}$
3028			$\begin{array}{l} \text{cm 6,5} \\ 7,6 \text{ --- } 10 \\ \diagup \end{array}$
3000			$\begin{array}{l} \text{cm 14} \\ 7,6 \text{ --- } 16 \\ \diagup \end{array}$
756			$\begin{array}{l} \text{cm 7,2} \\ 8 \text{ --- } 10,6 \\ \diagup \end{array}$
769			$\begin{array}{l} \text{cm 7} \\ 8 \text{ --- } 10,3 \\ \diagup \end{array}$
762			$\begin{array}{l} \text{cm 9,7} \\ 8,2 \text{ --- } 12,4 \\ \diagup \end{array}$
718			$\begin{array}{l} \text{cm 10,1} \\ 8,4 \text{ --- } 12,8 \\ \diagup \end{array}$
3015			$\begin{array}{l} \text{cm 8} \\ 8,5 \text{ --- } 11,5 \\ \diagup \end{array}$
3057			$\begin{array}{l} \text{cm 8,5} \\ 8,5 \text{ --- } 12,1 \\ \diagup \end{array}$
745			$\begin{array}{l} \text{cm 9,5} \\ 8,5 \text{ --- } 12,7 \\ \diagup \end{array}$
757			$\begin{array}{l} \text{cm 8} \\ 8,6 \text{ --- } 11,5 \\ \diagup \end{array}$
3014			$\begin{array}{l} \text{cm 10,2} \\ 8,8 \text{ --- } 13,5 \\ \diagup \end{array}$



715/S			$\begin{array}{l} \text{cm } 8,7 \\ \hline 8,8 \quad \diagup \quad 12,2 \end{array}$
719			$\begin{array}{l} \text{cm } 8,9 \\ \hline 10,5 \quad \diagup \quad 13,6 \end{array}$
295			$\begin{array}{l} \text{cm } 10,3 \\ \hline 9 \quad \diagup \quad 13,3 \end{array}$
3031			$\begin{array}{l} \text{cm } 11,2 \\ \hline 9,2 \quad \diagup \quad 14,2 \end{array}$
295/B			$\begin{array}{l} \text{cm } 10 \\ \hline 9,4 \quad \diagup \quad 13,5 \end{array}$
294			$\begin{array}{l} \text{cm } 9,2 \\ \hline 10,2 \quad \diagup \quad 13,5 \end{array}$
773			$\begin{array}{l} \text{cm } 9 \\ \hline 10 \quad \diagup \quad 13,4 \end{array}$
3039			$\begin{array}{l} \text{cm } 10,3 \\ \hline 10,1 \quad \diagup \quad 14 \end{array}$
3055			$\begin{array}{l} \text{cm } 10,1 \\ \hline 10,1 \quad \diagup \quad 14,2 \end{array}$
744			$\begin{array}{l} \text{cm } 10,8 \\ \hline 10,2 \quad \diagup \quad 15 \end{array}$
711			$\begin{array}{l} \text{cm } 8 \\ \hline 9 \quad \diagup \quad 12,2 \end{array}$
755			$\begin{array}{l} \text{cm } 8,5 \\ \hline 10,5 \quad \diagup \quad 13,5 \end{array}$
3056			$\begin{array}{l} \text{cm } 11,2 \\ \hline 11,2 \quad \diagup \quad 16 \end{array}$

lunghezza barre/length bars/morceau barres/Dauer pegelanzeige 150 cm

3052			$\begin{array}{l} \text{cm } 11,6 \\ 11,6 \quad \diagup \quad 16,2 \end{array}$
733			$\begin{array}{l} \text{cm } 16,5 \\ 11,8 \quad \diagup \quad 20,5 \end{array}$
760			$\begin{array}{l} \text{cm } 13 \\ 12,5 \quad \diagup \quad 18 \end{array}$
743			$\begin{array}{l} \text{cm } 13,5 \\ 12 \quad \diagup \quad 18 \end{array}$
785			$\begin{array}{l} \text{cm } 10,8 \\ 12 \quad \diagup \quad 16,3 \end{array}$
783			$\begin{array}{l} \text{cm } 14,5 \\ 14 \quad \diagup \quad 20 \end{array}$
716			$\begin{array}{l} \text{cm } 14,1 \\ 13,3 \quad \diagup \quad 19 \end{array}$
3054			$\begin{array}{l} \text{cm } 10 \\ 9,2 \quad \diagup \quad 13,5 \end{array}$
712			$\begin{array}{l} \text{cm } 13 \\ 12,5 \quad \diagup \quad 17,6 \end{array}$
713			$\begin{array}{l} \text{cm } 19,6 \\ 12,7 \quad \diagup \quad 22 \end{array}$



lunghezza barre/length bars/morceau barres/Dauer pegelanzeige 150 cm

KARNIZAI SU PAPILDOMAIS ELEMENTAIS

3046

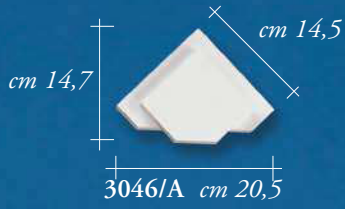
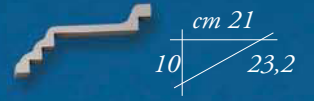

3046 + 3046/A

3046 + 3046/B

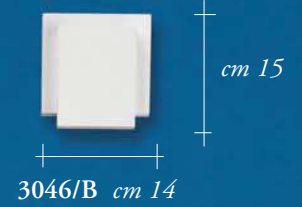

3046/B cm 14

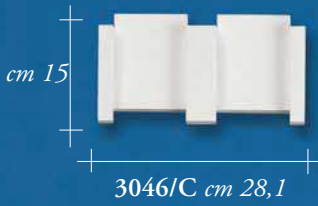

3046/C cm 28,1



3046 + 3046/C

3046 + 3046/D



3046/D cm 30



3046 + 3046/A

3046 + 3046/C

3046 + 3046/D

3046 + 3046/B

3044

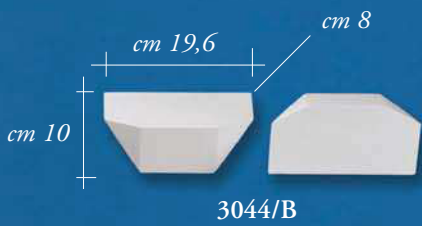
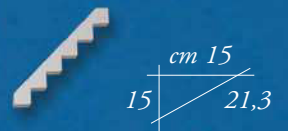

3044/B

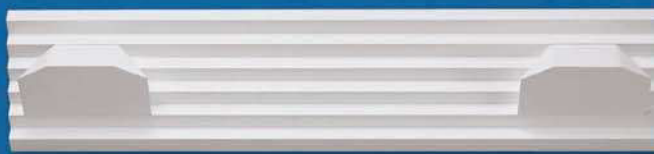

3044 + 3044/B

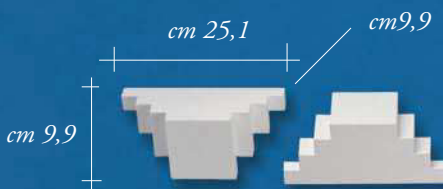

3044/A



3044 + 3044/A



3044 + 3044/A + 3044/B

lunghezza barre/length bars/morceau barres/Dauer pegelanzeige 150 cm

KARNIZAI DIDEĻI

799

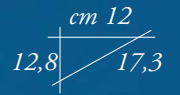

297

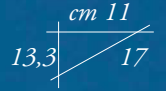

3033

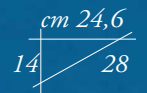

3034

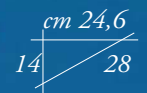

731

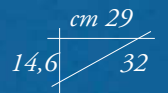

730

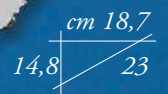

764

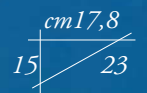

765

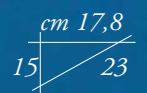



lunghezza barre/length bars/morceau barres/Dauer pegelanzeige 150 cm

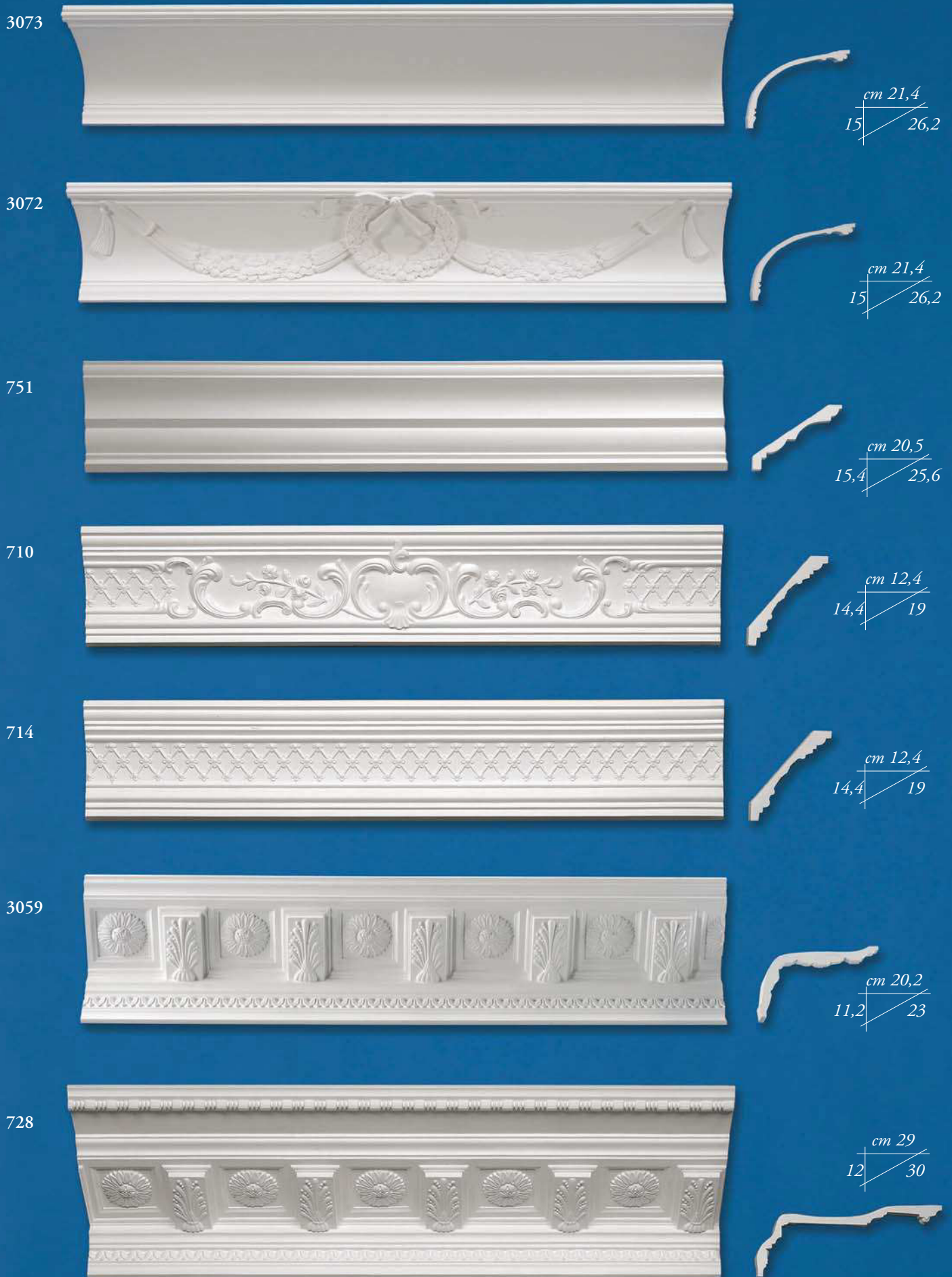

lunghezza barre/length bars/morceau barres/Dauer pegelanzeige 150 cm

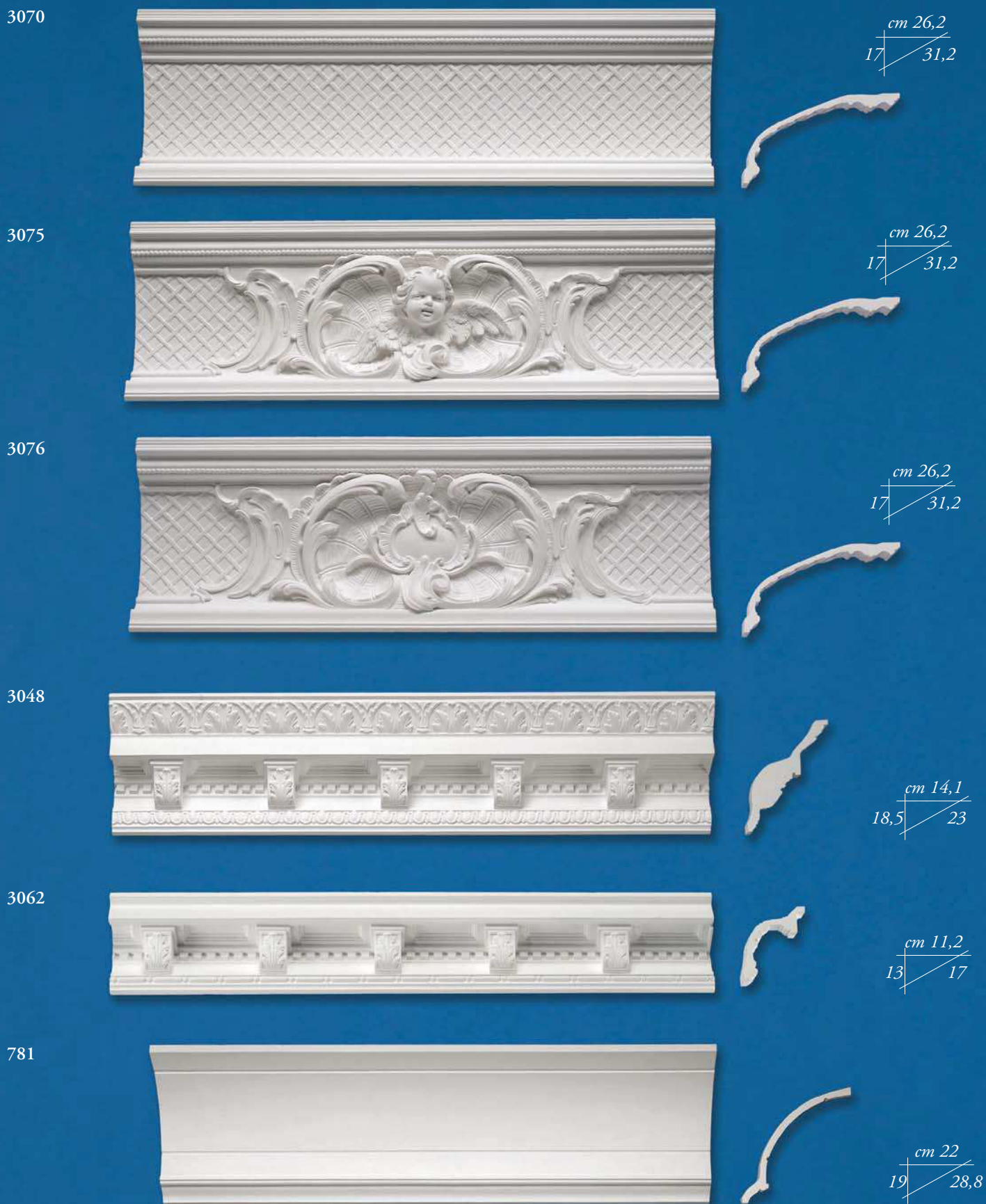



lunghezza barre/length bars/morceau barres/Dauer pegelanzeige 150 cm

3074



cm 31,4  
19,1 / 36,8



3074  
+ 3074/C



cm 31,4  
19,1 / 36,8



3074/C

3026



cm 21  
20,5 / 29,4



729



cm 32,5  
18,4 / 37



739



cm 22  
20,7 / 30



8/S



cm 15,2  
21 / 25,8



9/S



cm 15,2  
21 / 25,8



SGUSCIONI • corniches • cover-angles • schalen • kooflijsten

lunghezza barre/length bars/morceau barres/Dauer pegelanzeige 150 cm

736



cm 30,4  
21,9 / 37

3047



cm 19,6  
22,4 / 29,5

3071



cm 21,4  
21,8 / 29,6

lunghezza barre 145,6 cm

3065



cm 26,3  
37,9 / 46,4

lunghezza barre 145 cm

3064



cm 28,1  
39,2 / 48,1

lunghezza barre 140 cm

3063



cm 34,8  
38,7 / 51,4

lunghezza barre 132 cm

3066



3066/A

cm 25,7

lunghezza barre 153,3 cm

3067



cm 20  
49 / 52,9

3066/C

cm 20  
49 / 52,9



lunghezza barre/length bars/morceau barres/Dauer pegelanzeige 150 cm - \* 200cm

PCA-200  
\*

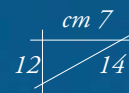

PCE-200  
\*

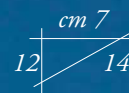

PCD-200  
\*

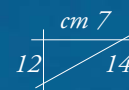

PCG-200  
\*

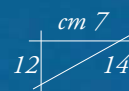

PCS-200  
\*

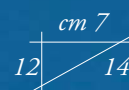

G 3

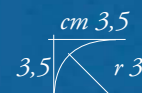
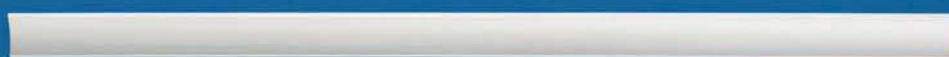

G 5

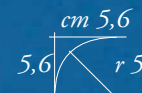

G 7

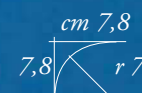

G 10

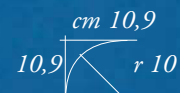

G 15

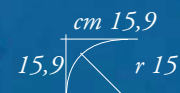



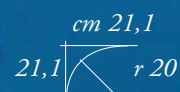









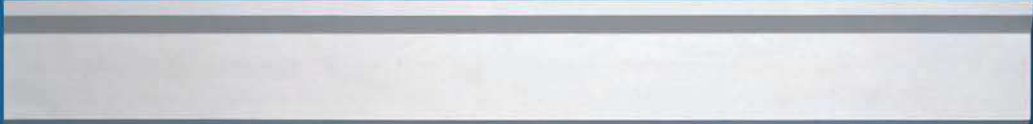

G 20

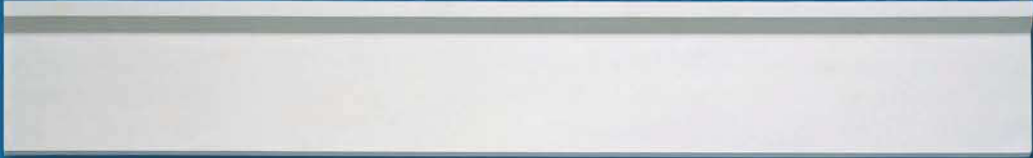

lunghezza barre/length bars/morceau barres/Dauer pegelanzeige 150 cm

ATRAMINIAI ELEMENTAI UŽUOLAIĐŲ KARNIZAMS

		MAN 8 MAN 8
		MAN 10 MAN 10
		MAN 12 MAN 12
		MAN 14 MAN14
		MAN 16 MAN 16
		MAN 18 MAN 18
		MAN 20 MAN 20



altezza  
8 cm  
10 cm  
12 cm  
14 cm  
16 cm  
18 cm  
20 cm  
22 cm

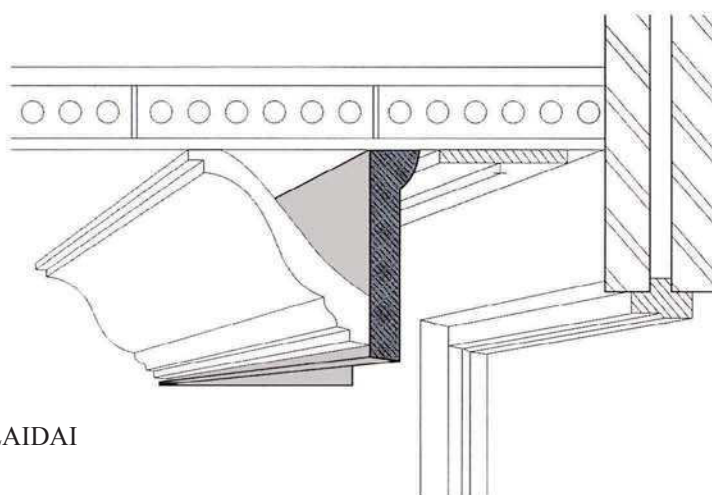

KARNIZAS UŽUOLAI DAI



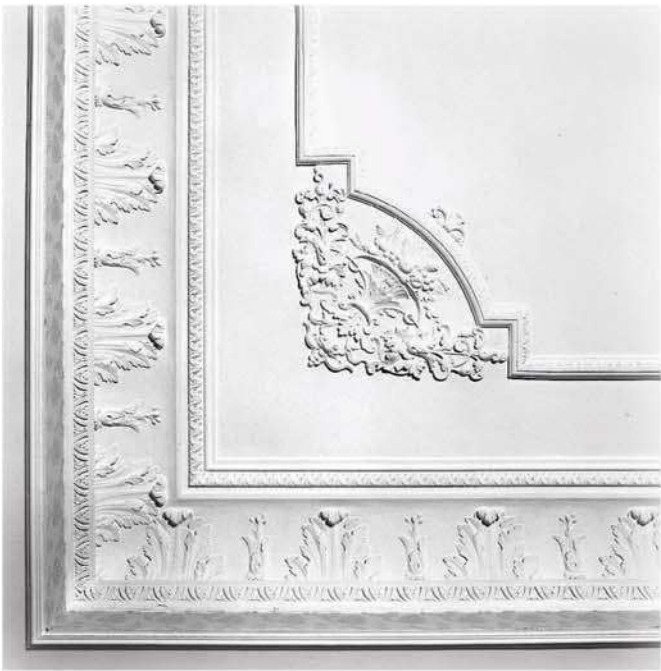

lunghezza barre/lunghezza barre/lunghezza barrelunghezza barre 1000 mm



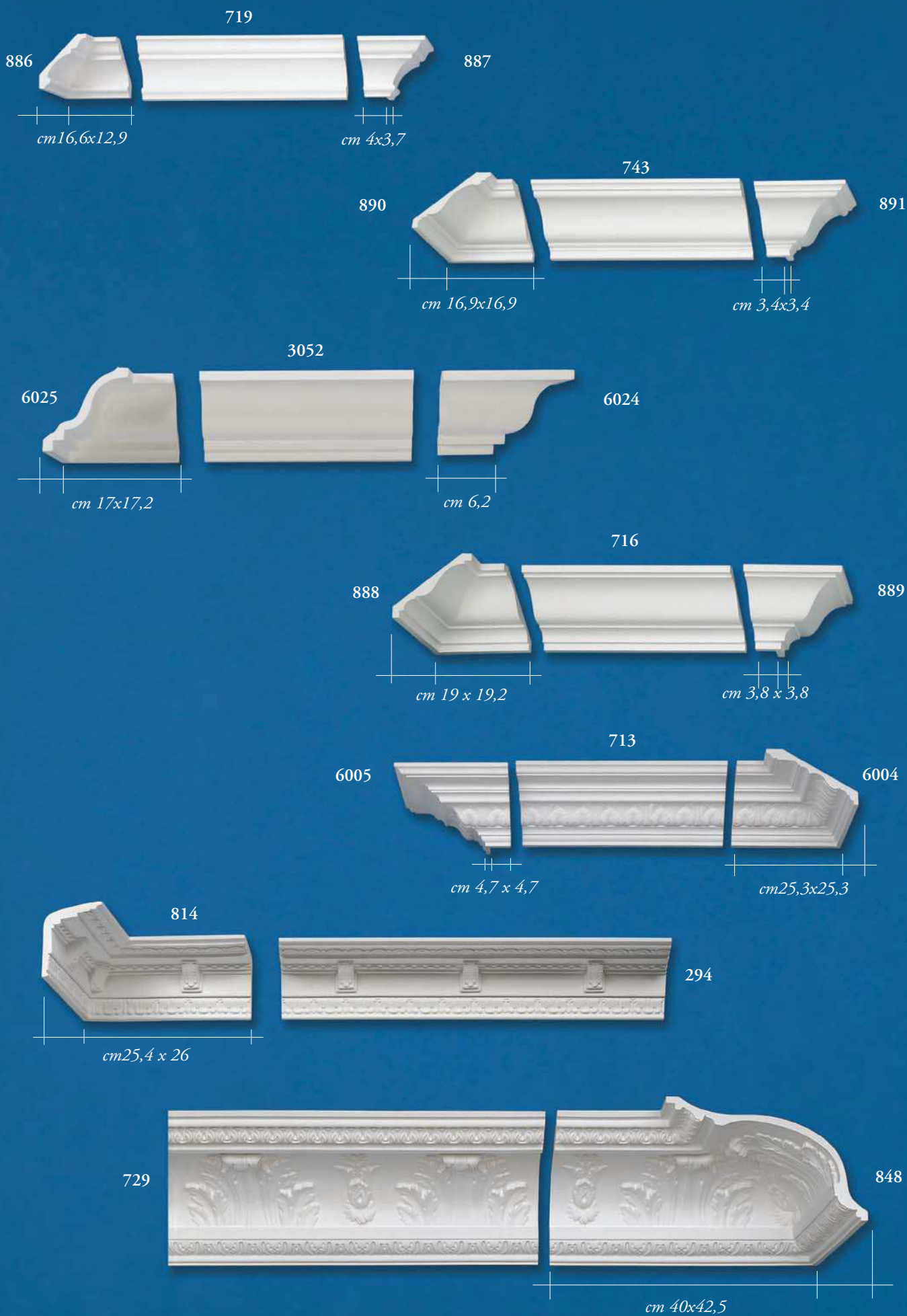



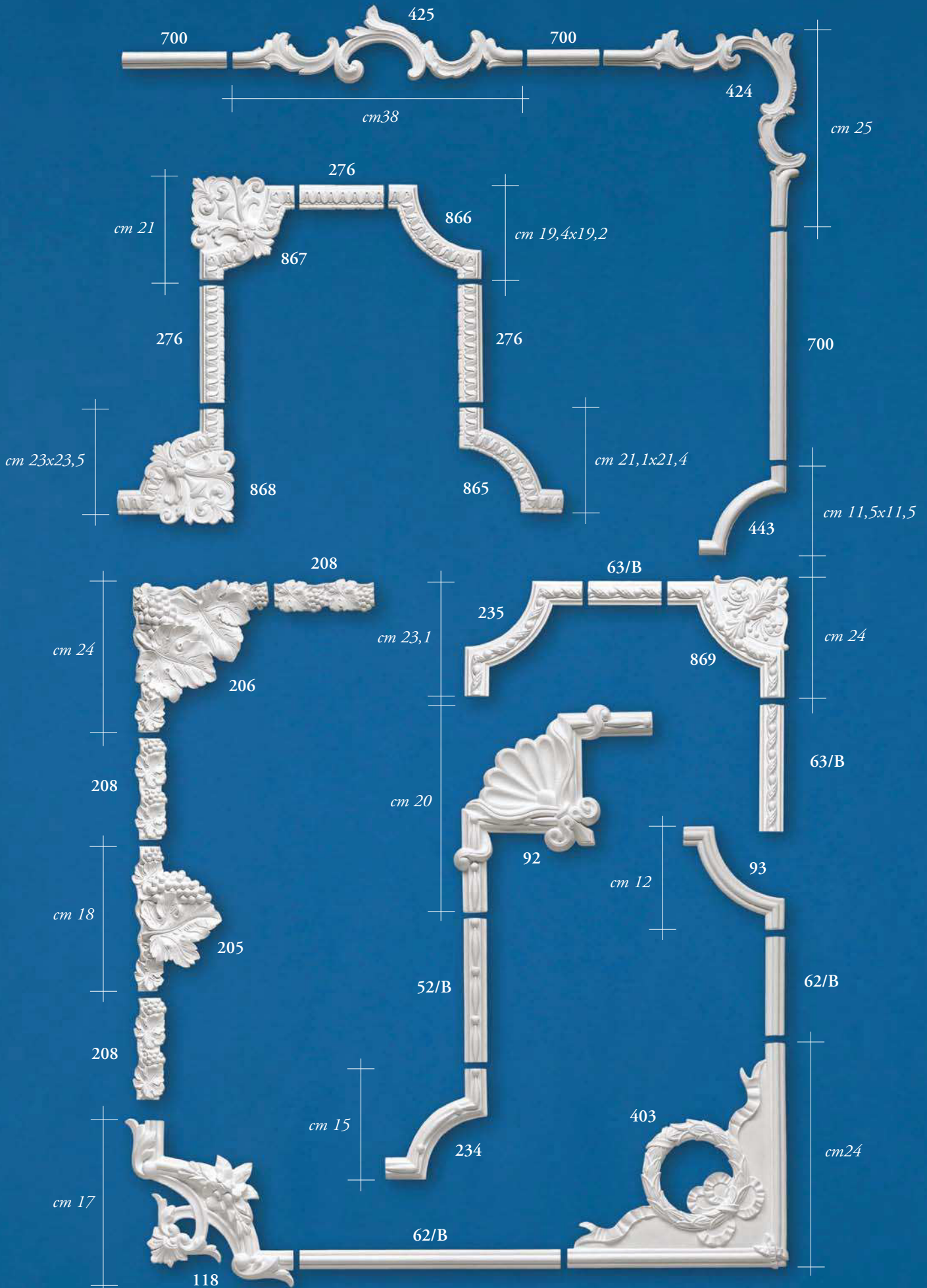

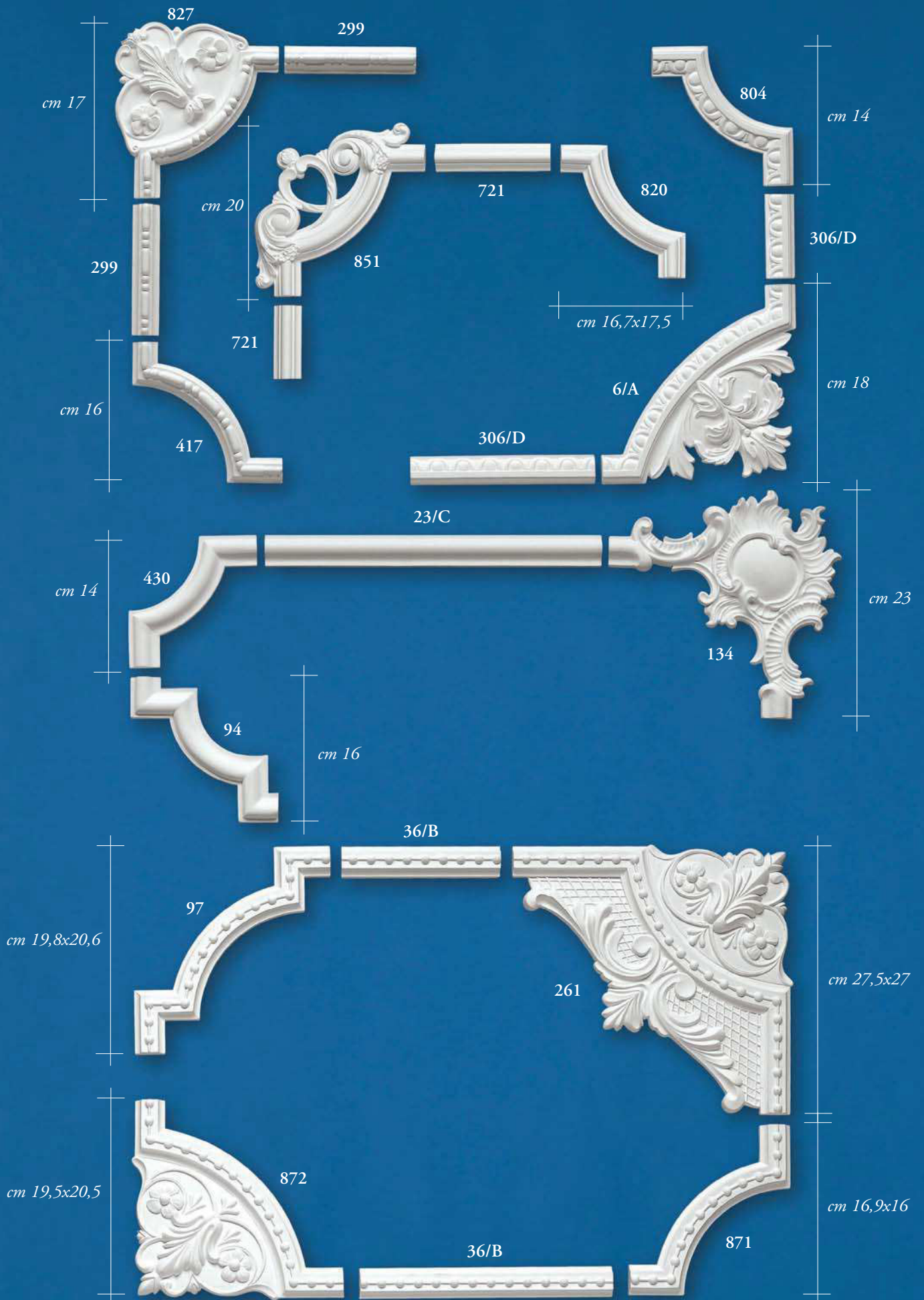



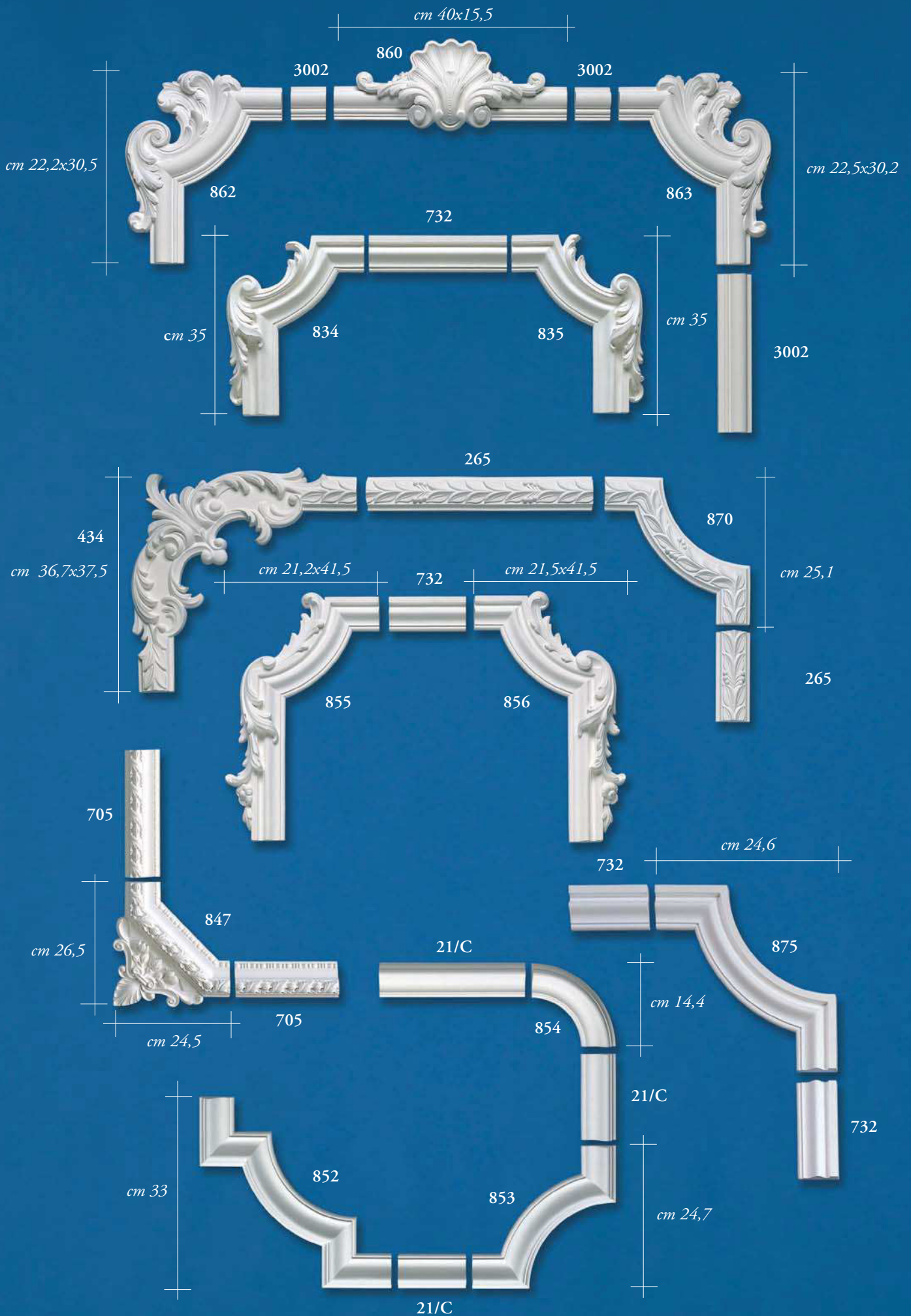



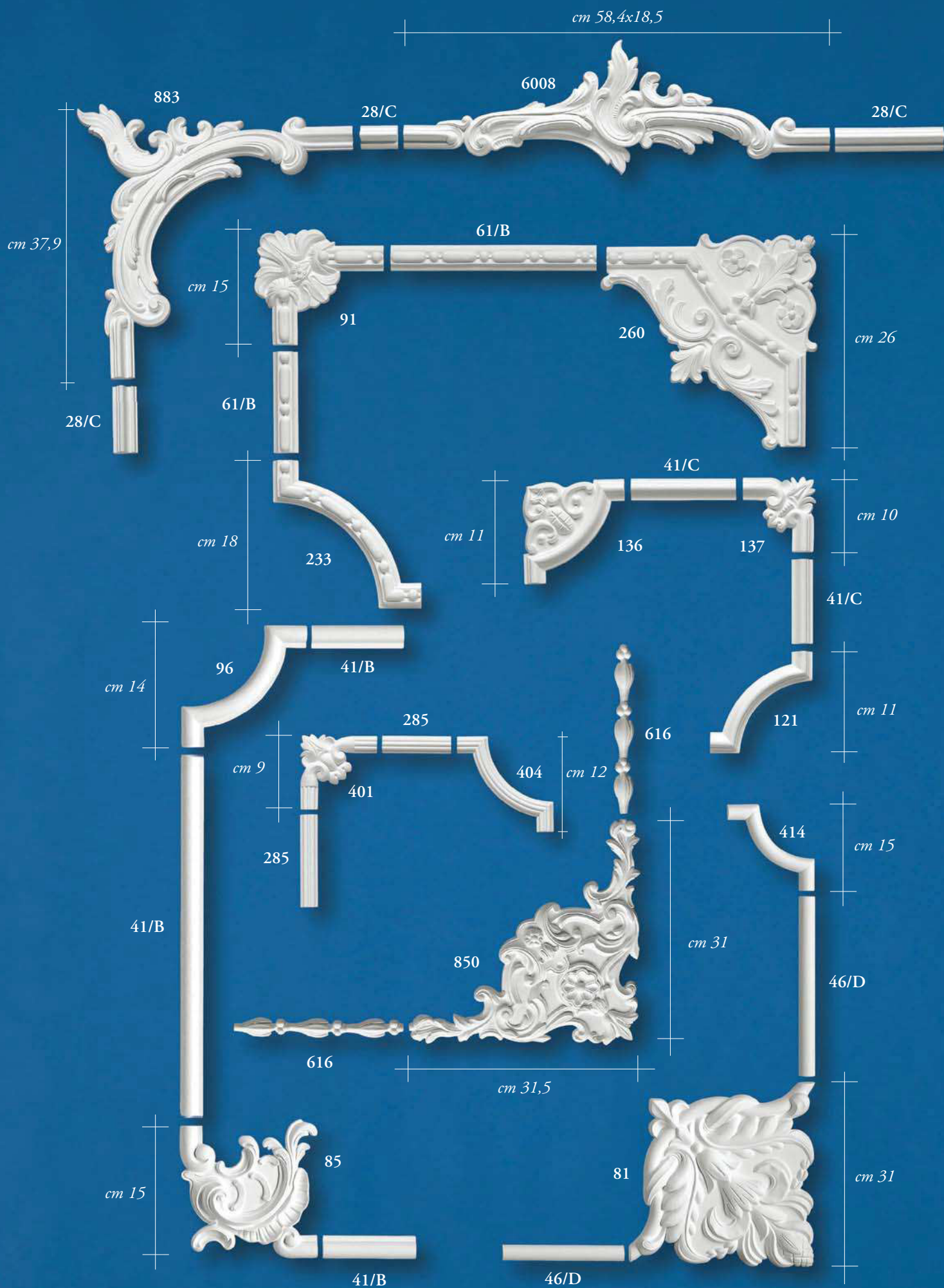

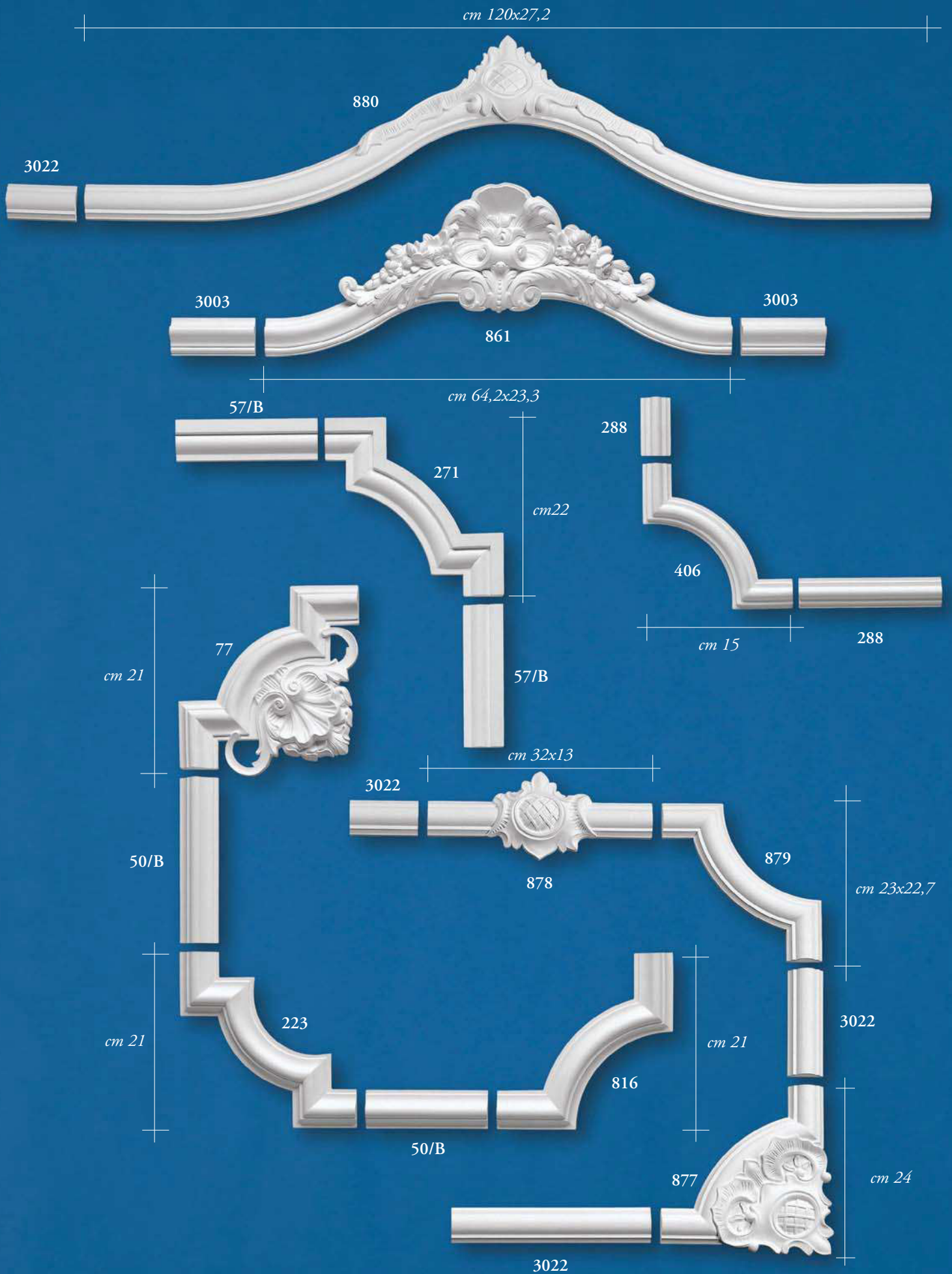



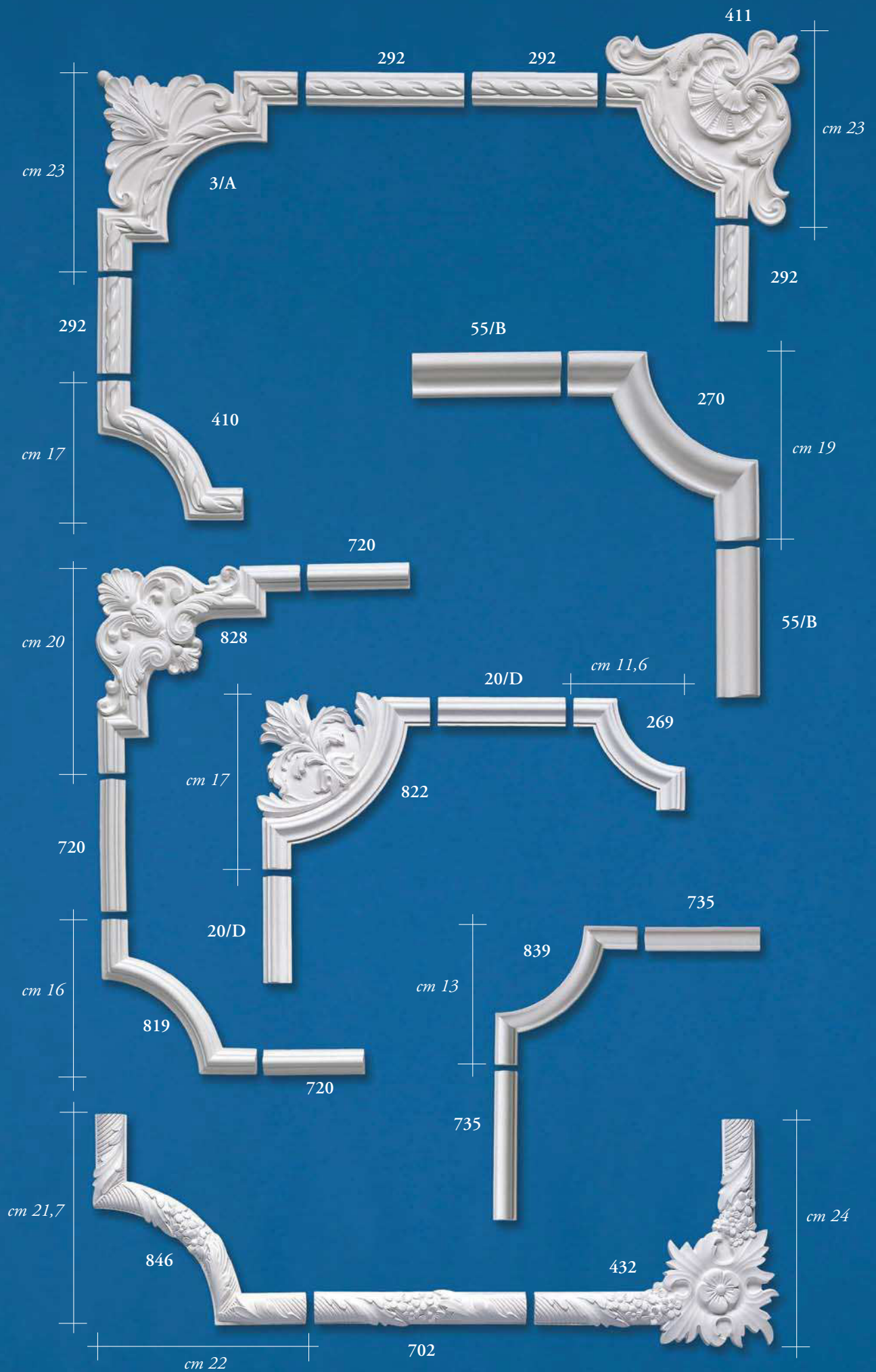



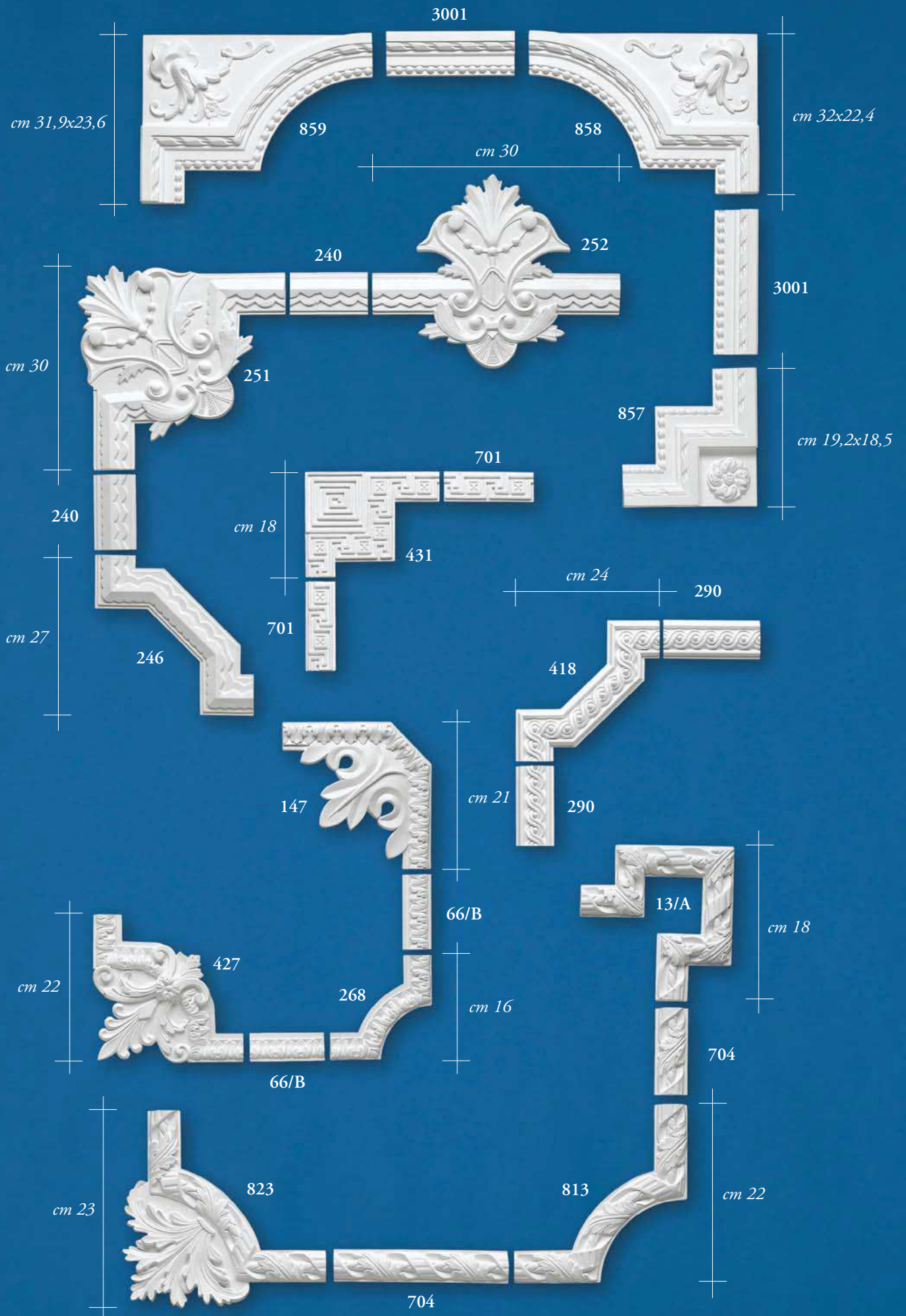

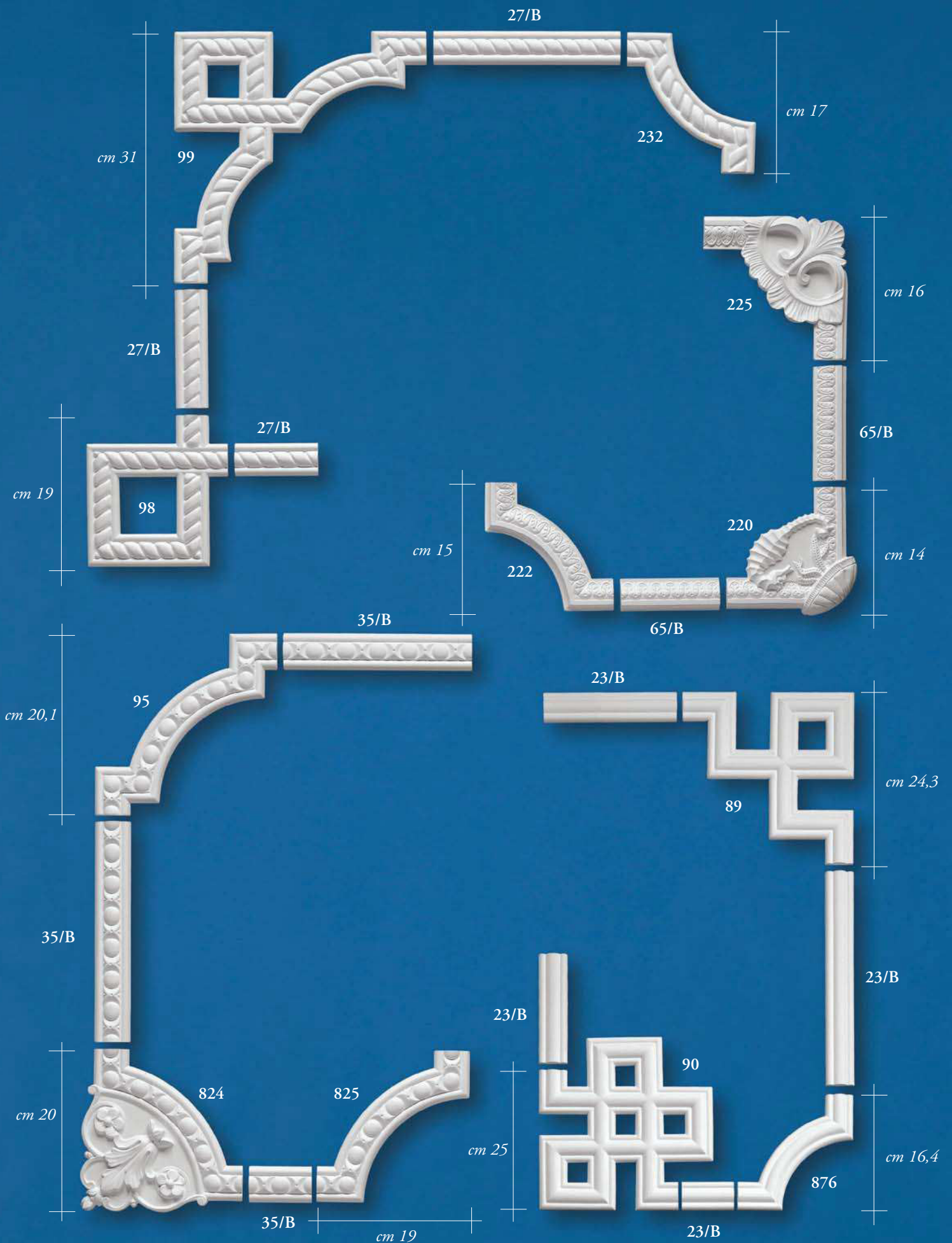



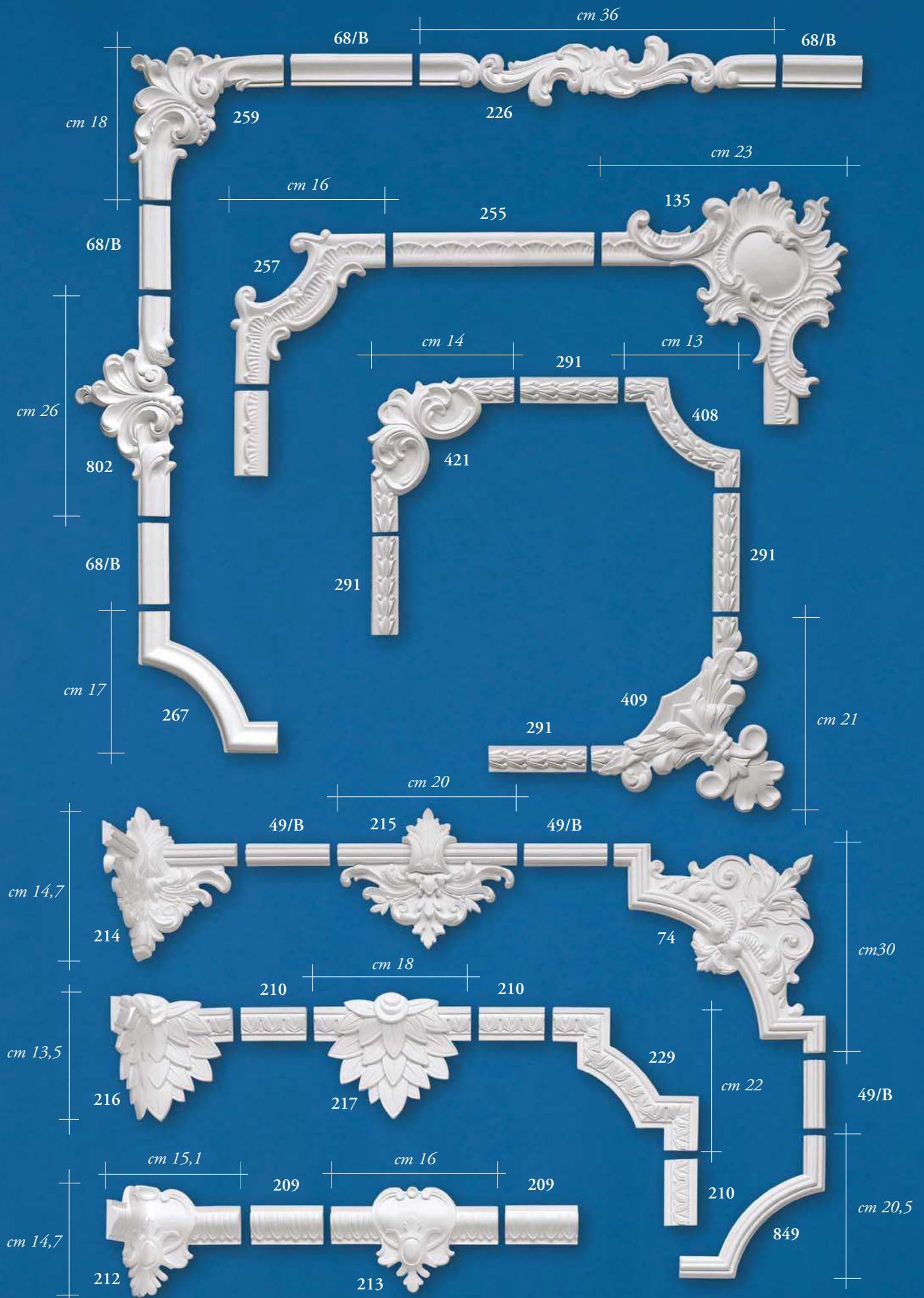



38/B

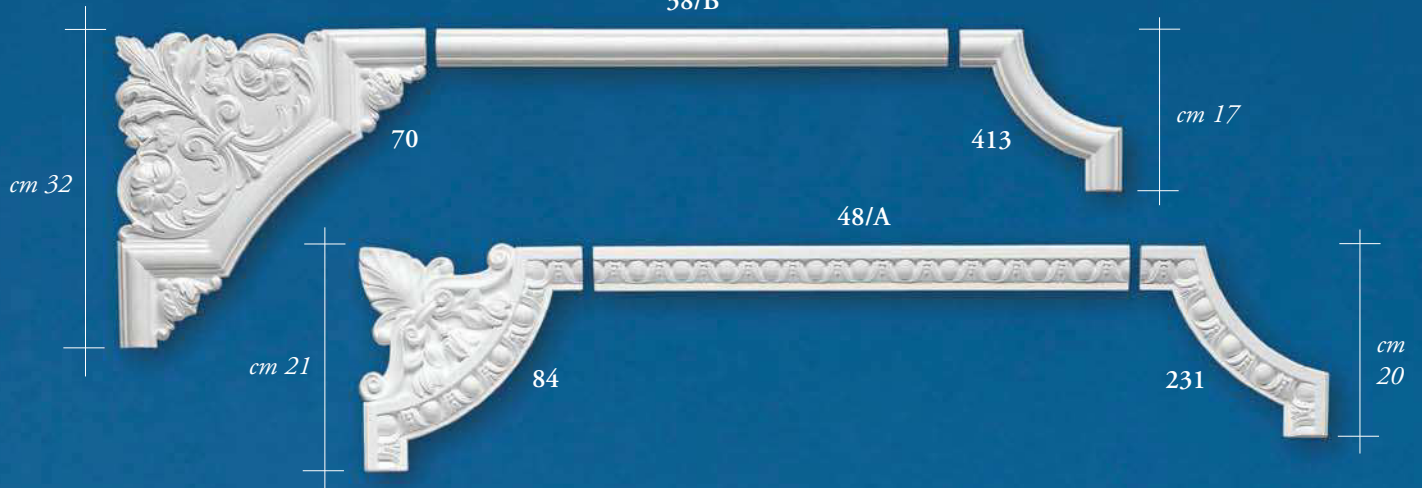

24/B

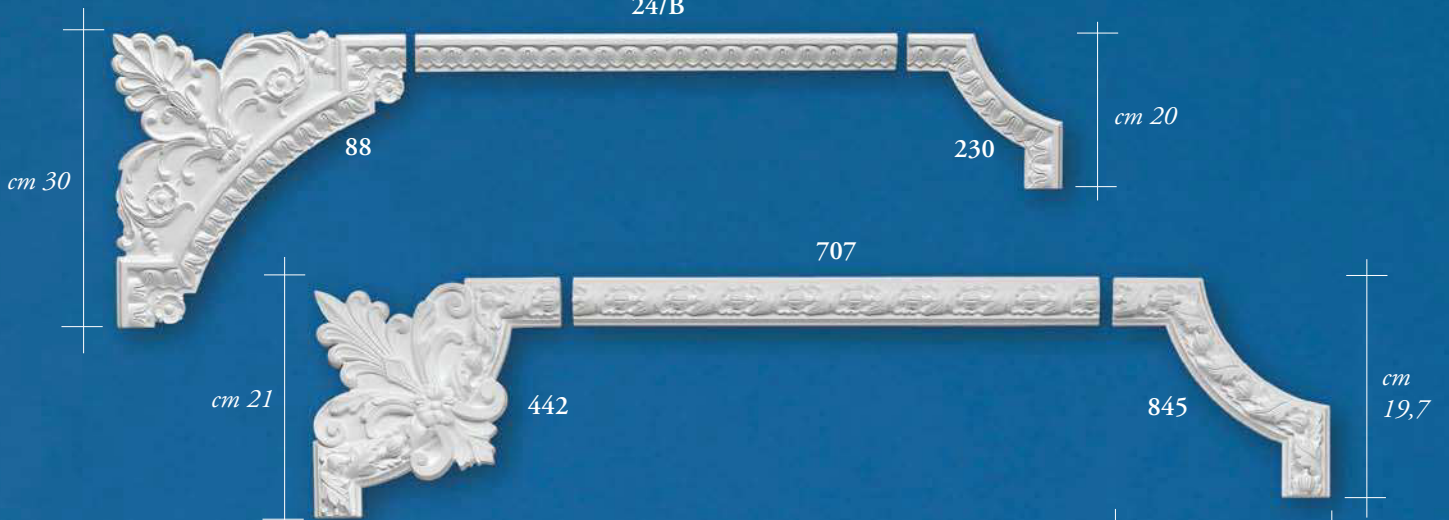

707



706

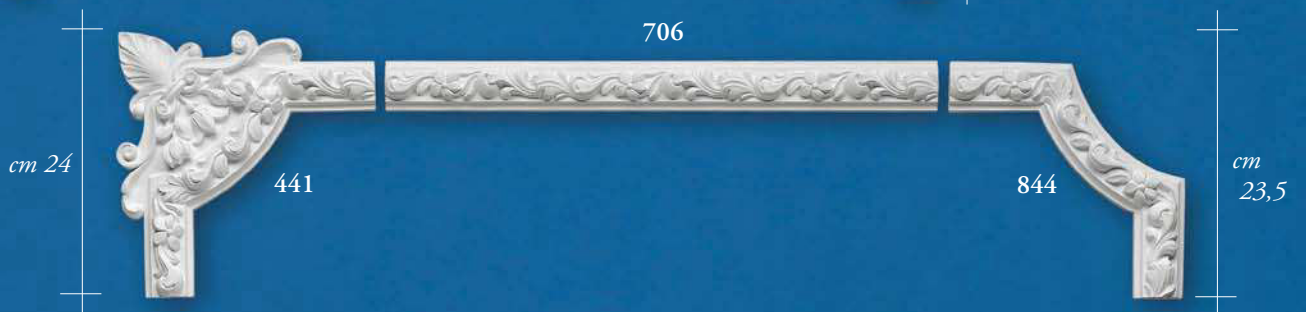

284



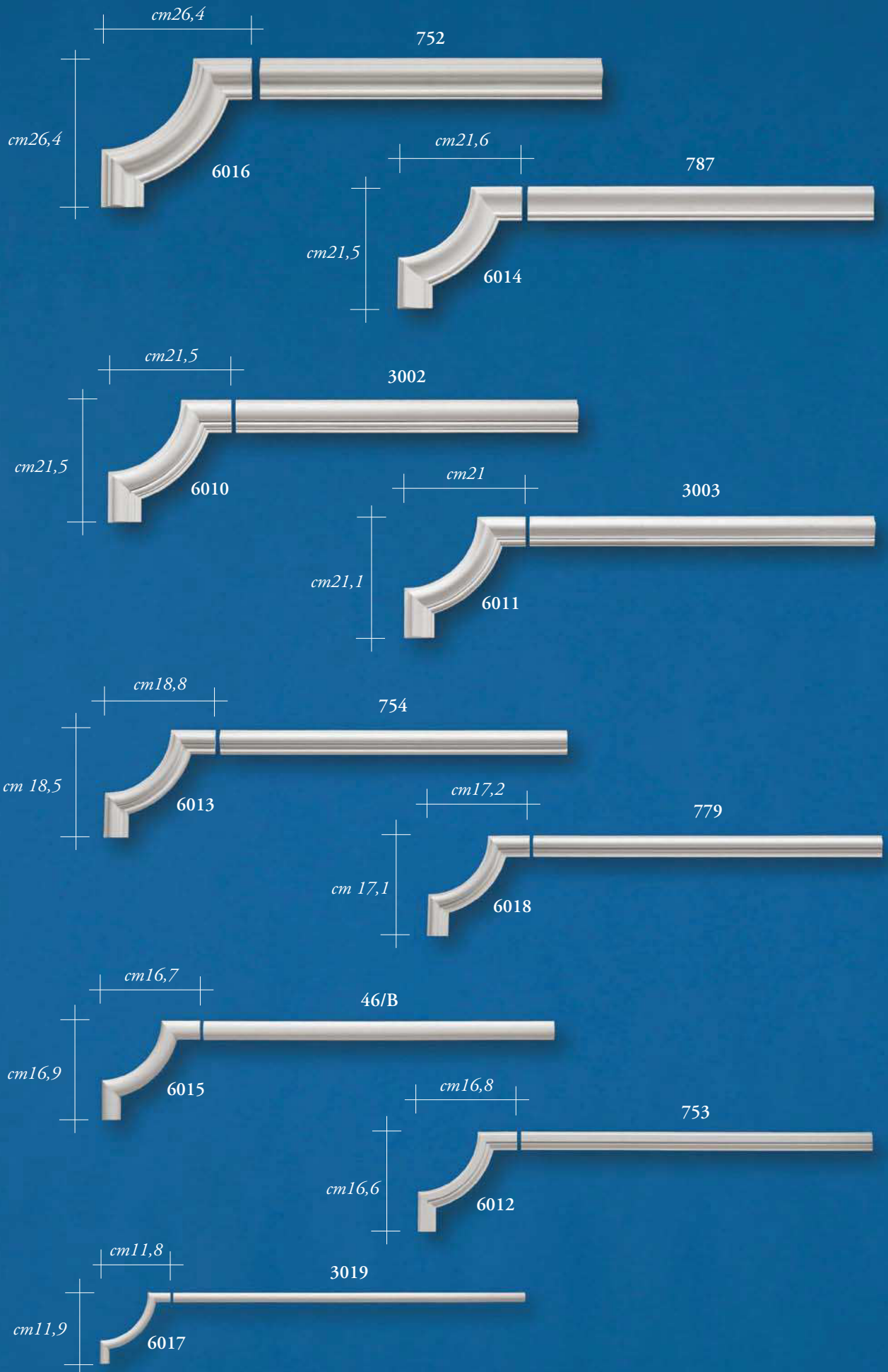

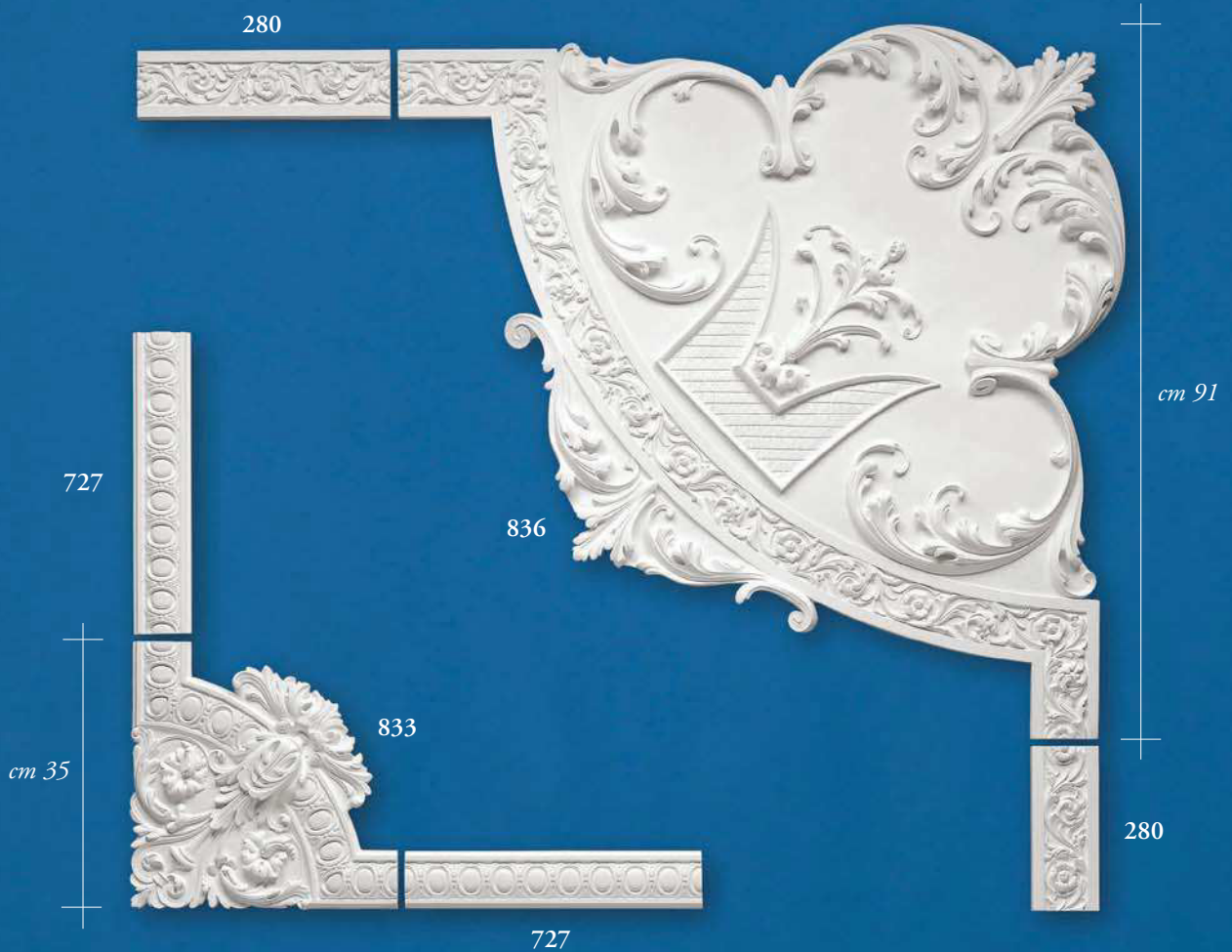



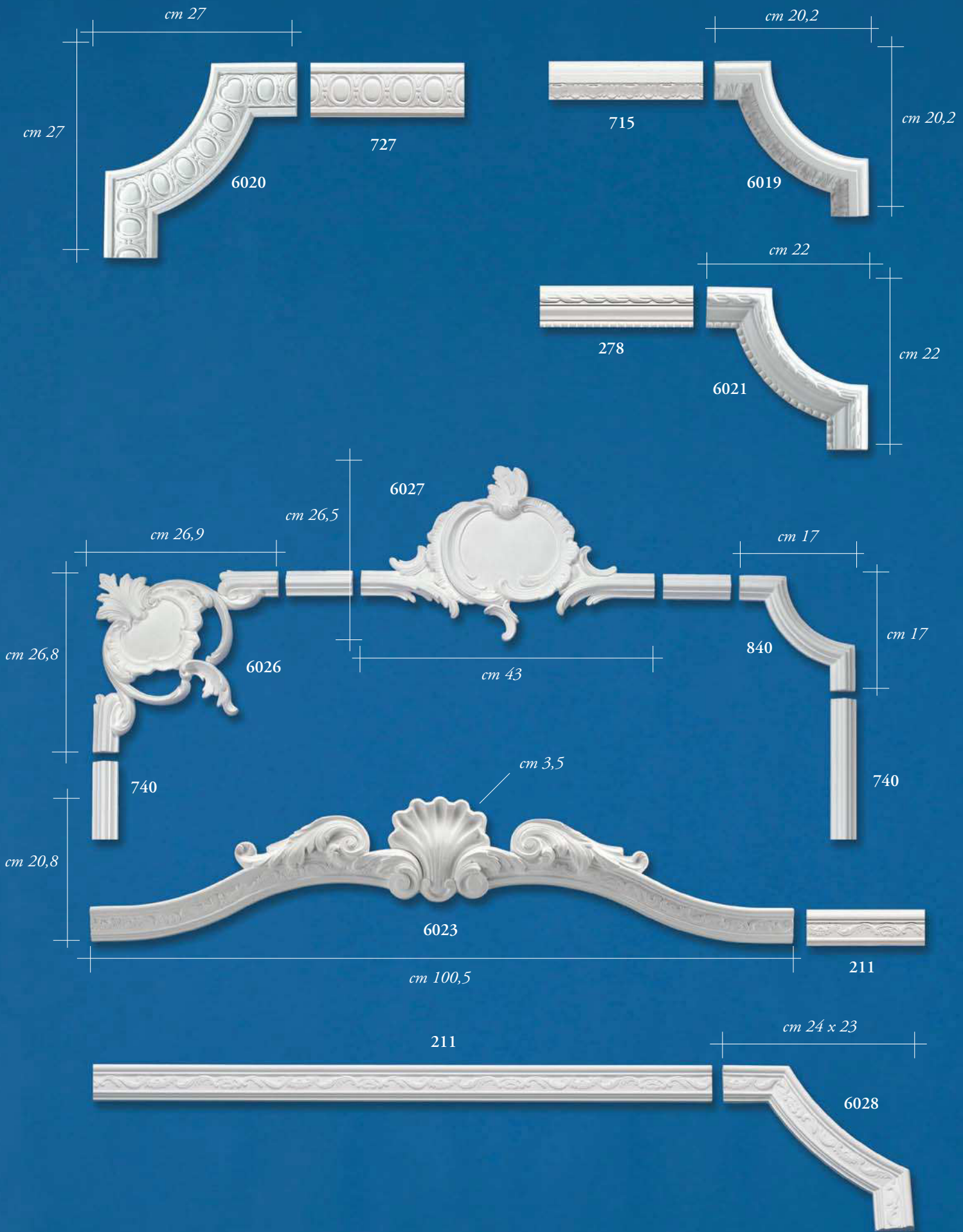

ORNAMENTAI

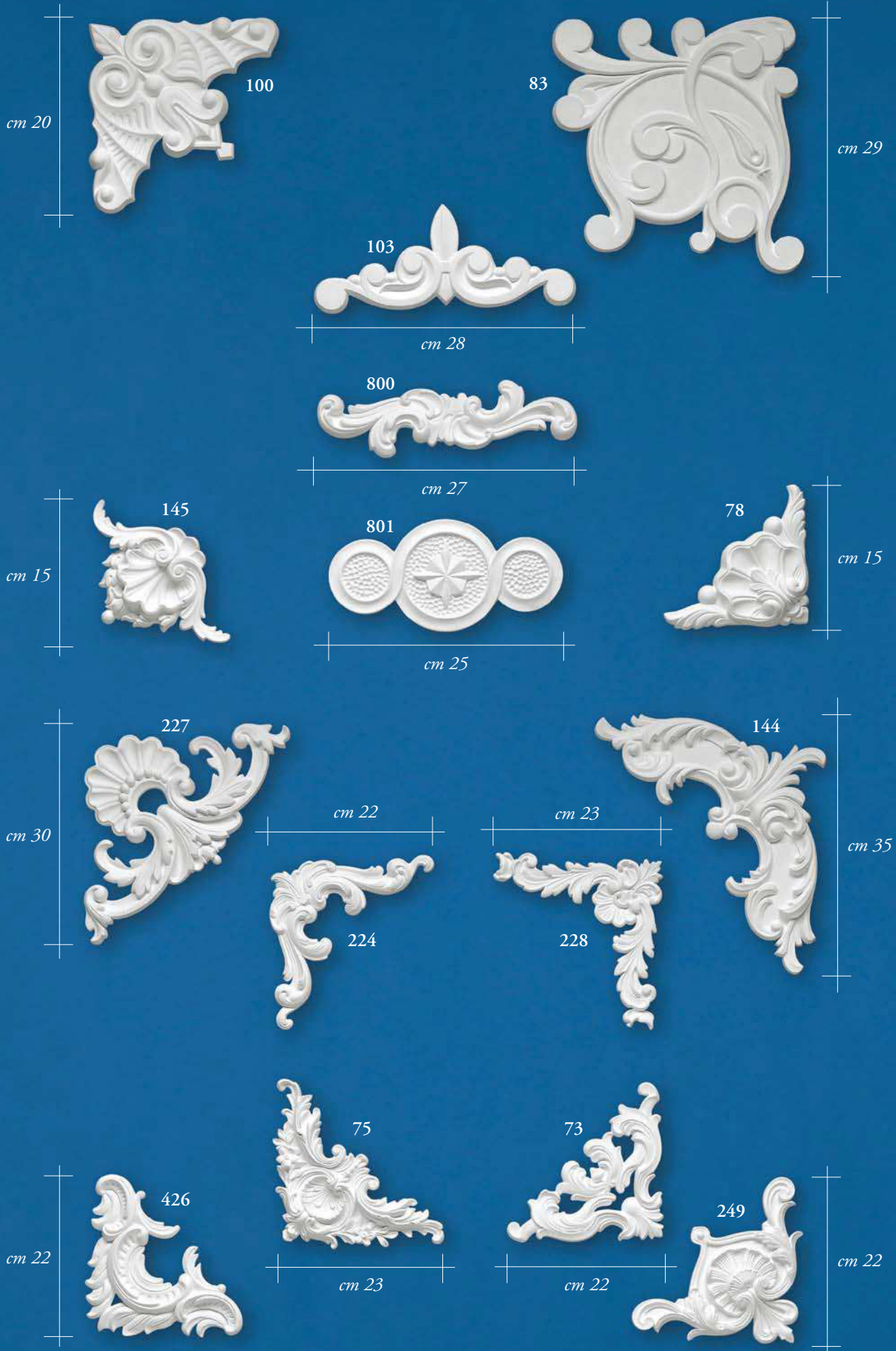



ANGELAI, ORNAMENTAI LUBOMS



r 80

892

cm 60,3

KAMPAI GALI BŪTI ĮLEISTI Į LUBAS (SIENA)

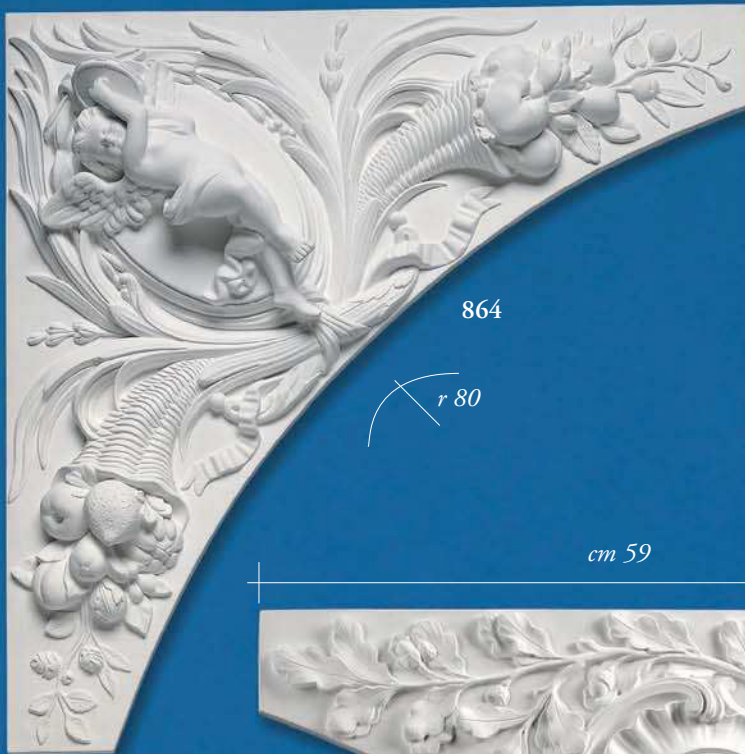

cm 60,2

864

r 80

cm 8,5

cm 59

cm 8,5



6022

cm 58,8

r 80

cm 8,5



101/L

cm 55





KARNIZAI APŠVIETIMUI (APŠVIETIMINIAI)

lunghezza barre 150 cm



14/S

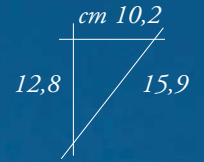

884

14/S

885

cm 16,4x16,4

cm 4,5x4,7



12/S

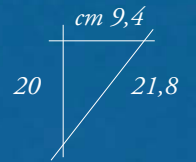

13/S

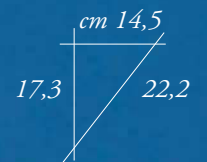

894

13/S

893

cm 5,3x5,8

cm 21,4x20,8



6/SA

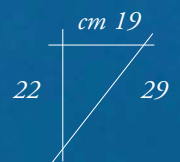

lunghezza barre 150 cm



6/S

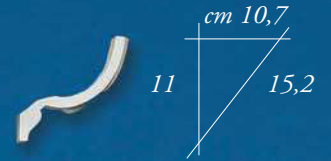

4/S

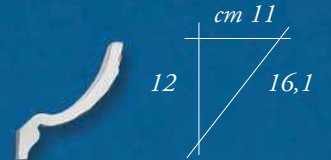

1/S

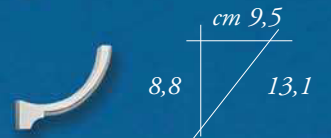

2/S

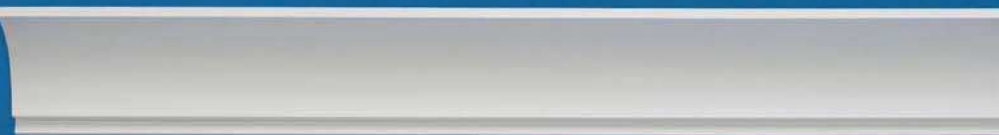
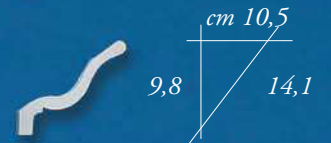

15/S

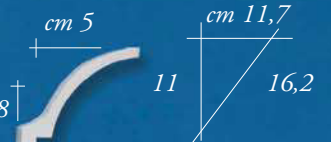

11/S

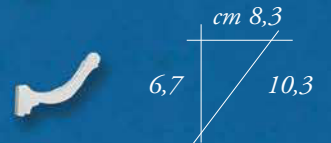

4/S

cm 6,8x3,8

cm 17

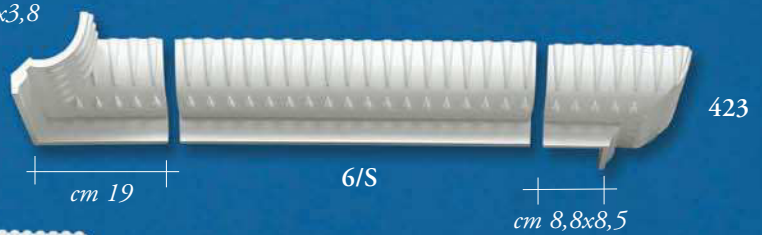

6/S

cm 8,8x8,5

cm 19

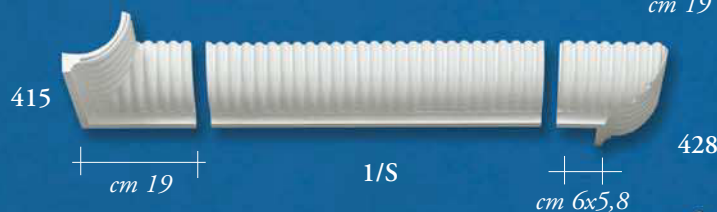

1/S

cm 6x5,8

cm 19



2/S

cm 7,8x7,6

cm 17



11/S

cm 6,4x6

cm 13



ŠVIESTUVAI SIENINIAI



19 *A cm 31 B 27 C 9,5*



1002 *A cm 25 B 22,8 C 12,5*



140 *A cm 26 B 23 C 14*



1001 *A cm 35 B 17,5 C 12,5*



416 *A cm 34,5 B 20,5 C 10*



138 *A cm 21,5 B 22 C 12*



1000 *A cm 28 B 14,2 C 13,8*



1019 A cm 74 B 9,8 C 19,8



1020 A cm 74 B 9,8 C 19,8



1017 A cm 44,5 B 11,5 C 16,8



1022 A cm 27,5 B 14,4 C 15,6



1016 A cm 23,6 B 10,4 C 11,2



1021 A cm 28 B 14,4 C 14



1015 A cm 44,5 B 11,5 C 16,8



1010 A cm 32 B 18 C 18,3



1008 A cm 41,5 B 16,5 C 17



1009 A cm 34,5 B 21,5 C 18,5





1012 A cm 43 B 18 C 27,5



1013 A cm 45 B 15 C 29



1011 A cm 43 B 13,5 C 21,7



1014 A cm 41,5 B 14,7 C 20,4



1023 A cm 30 B 19,5 C 19



1003 A cm 30 B 19,5 C 19



1007 A cm 21,8 B 23



1005 A cm 21,8 B 23

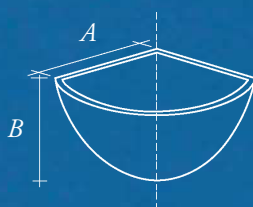

1024 A cm 16,8 B cm 14



1025 A cm 16,8 B cm 14

1004 A cm 41,5 B 22,5 C 18



1006 A cm 41,5 B 22,5 C 18



1018 A cm 42 B 12,8 C 17,7







# RIVESTIMENTO PER COLONNE

pilastres • coating for columns • säulenverkleidung • kolommen

PILIASTRAI, KAMPINIS PILIASTRAS

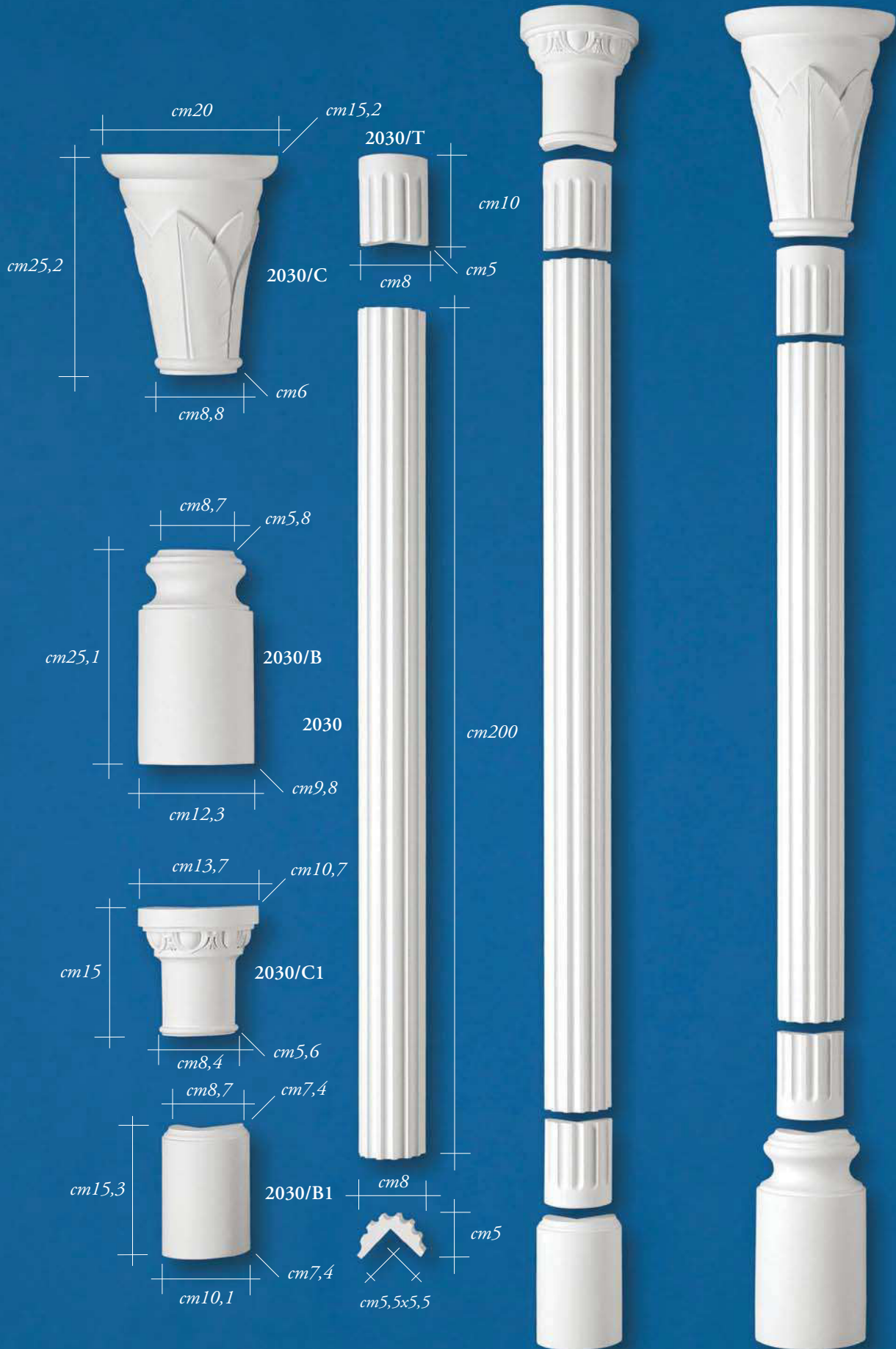

# RIVESTIMENTO PER COLONNE

pilastres • coating for coloumns • säulenverkleidung • kolommen

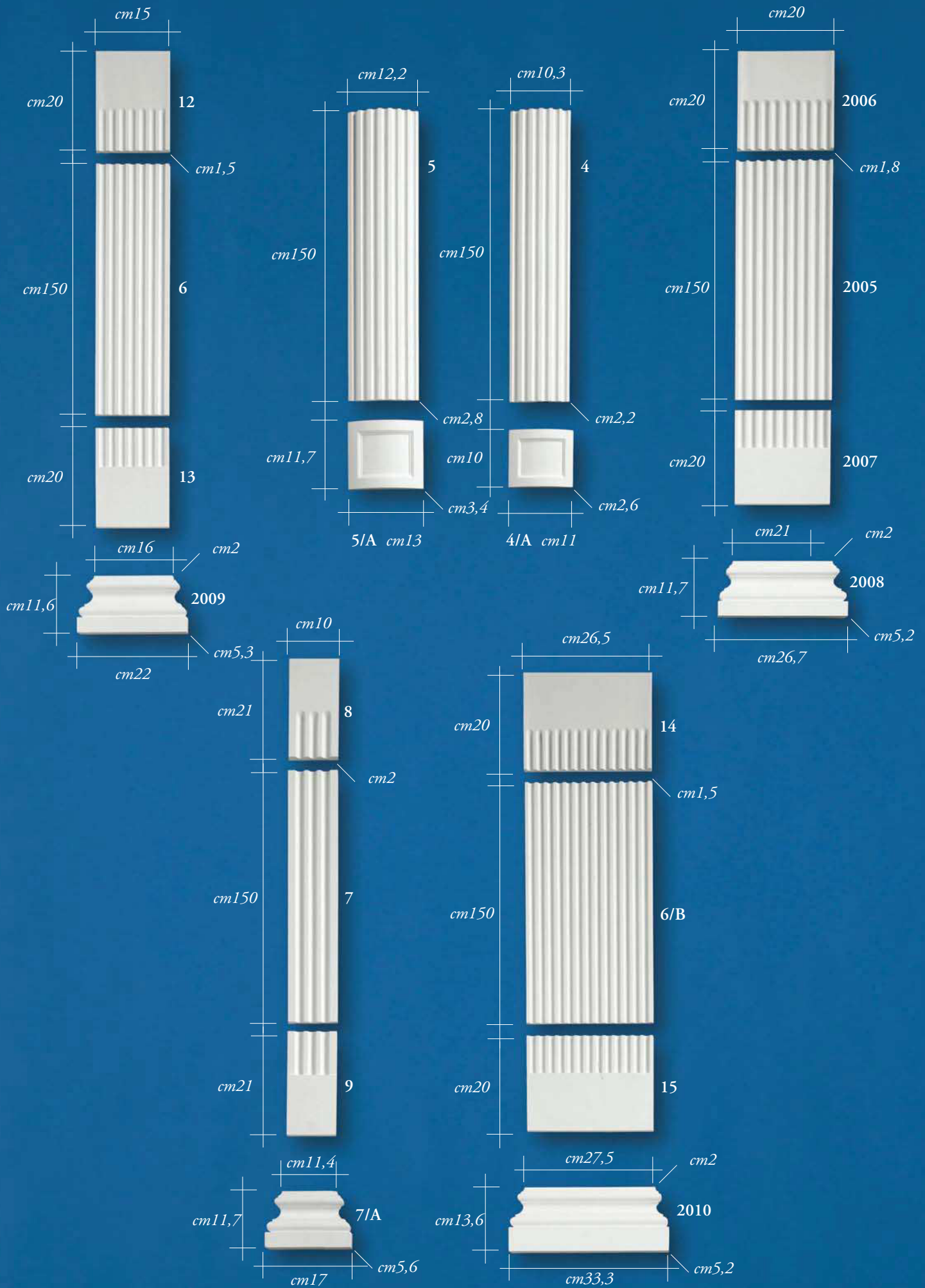



# RIVESTIMENTO PER COLONNE

pilastres • coating for coloumns • säulenverkleidung • kolommen

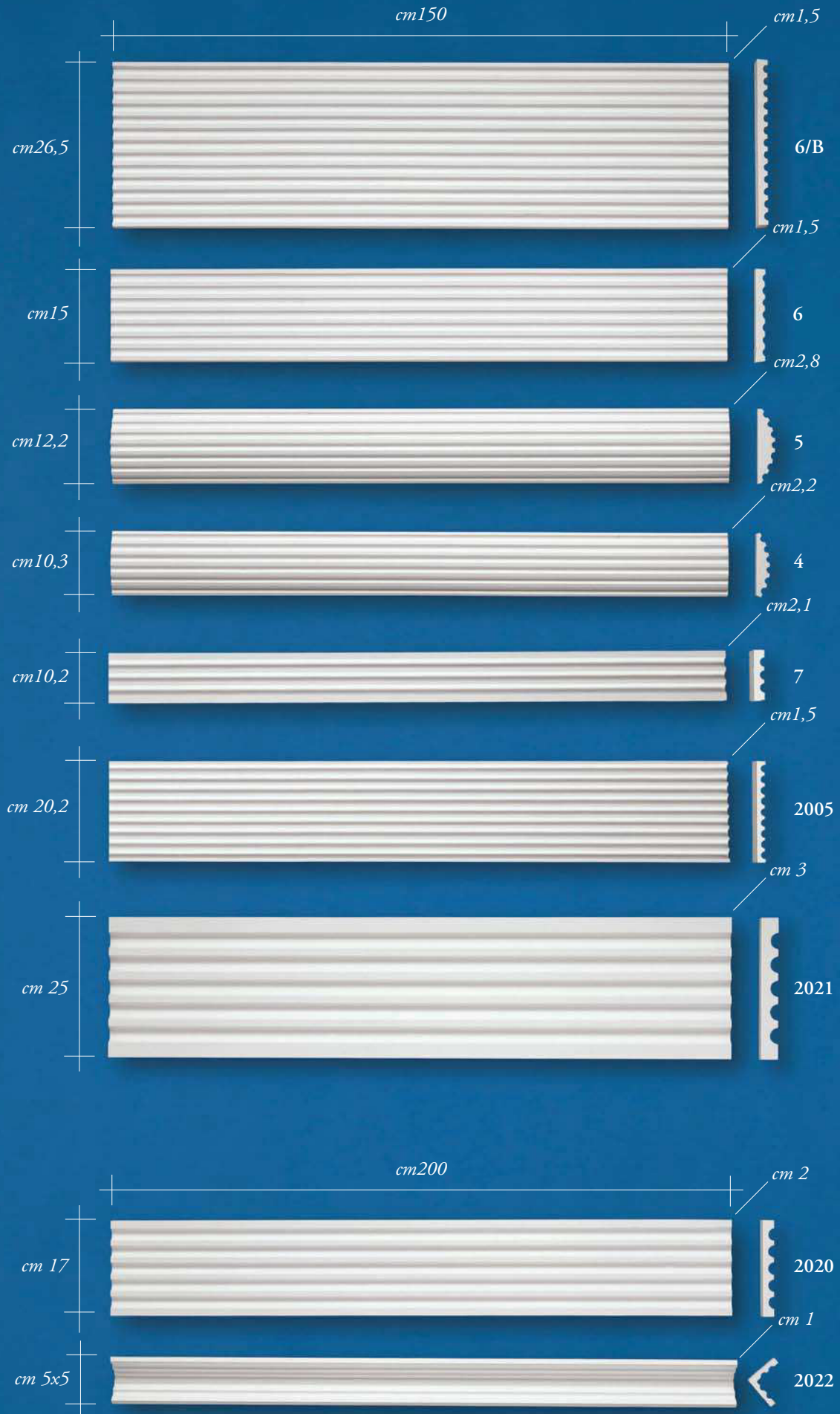

# RIVESTIMENTO PER COLONNE

pilastres • coating for coloumns • säulenverkleidung • kolommen

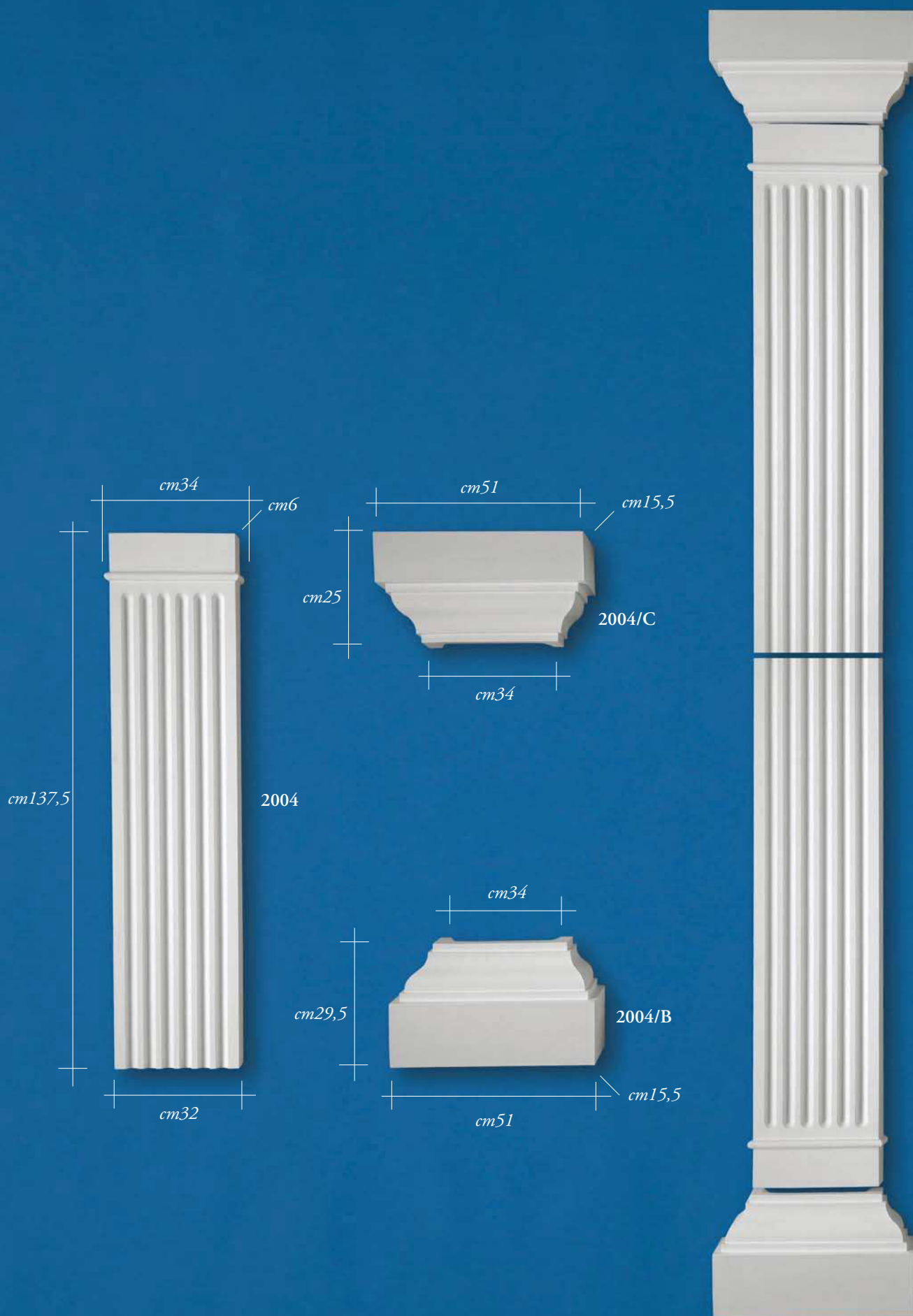

# RIVESTIMENTO PER COLONNE

pilastres • coating for coloumns • säulenverkleidung • kolommen

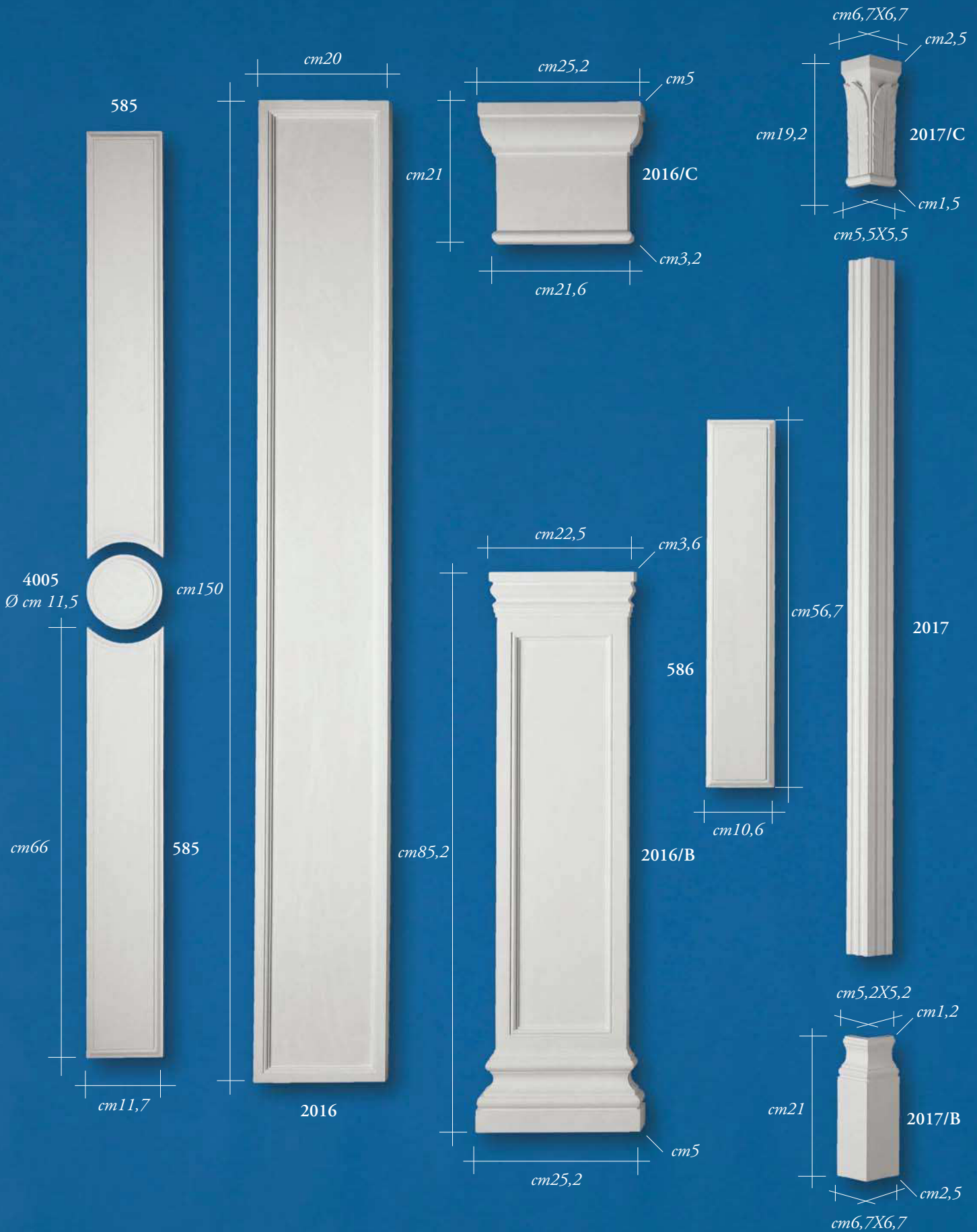



# RIVESTIMENTO PER COLONNE

pilastres • coating for coloumns • säulenverkleidung • kolommen

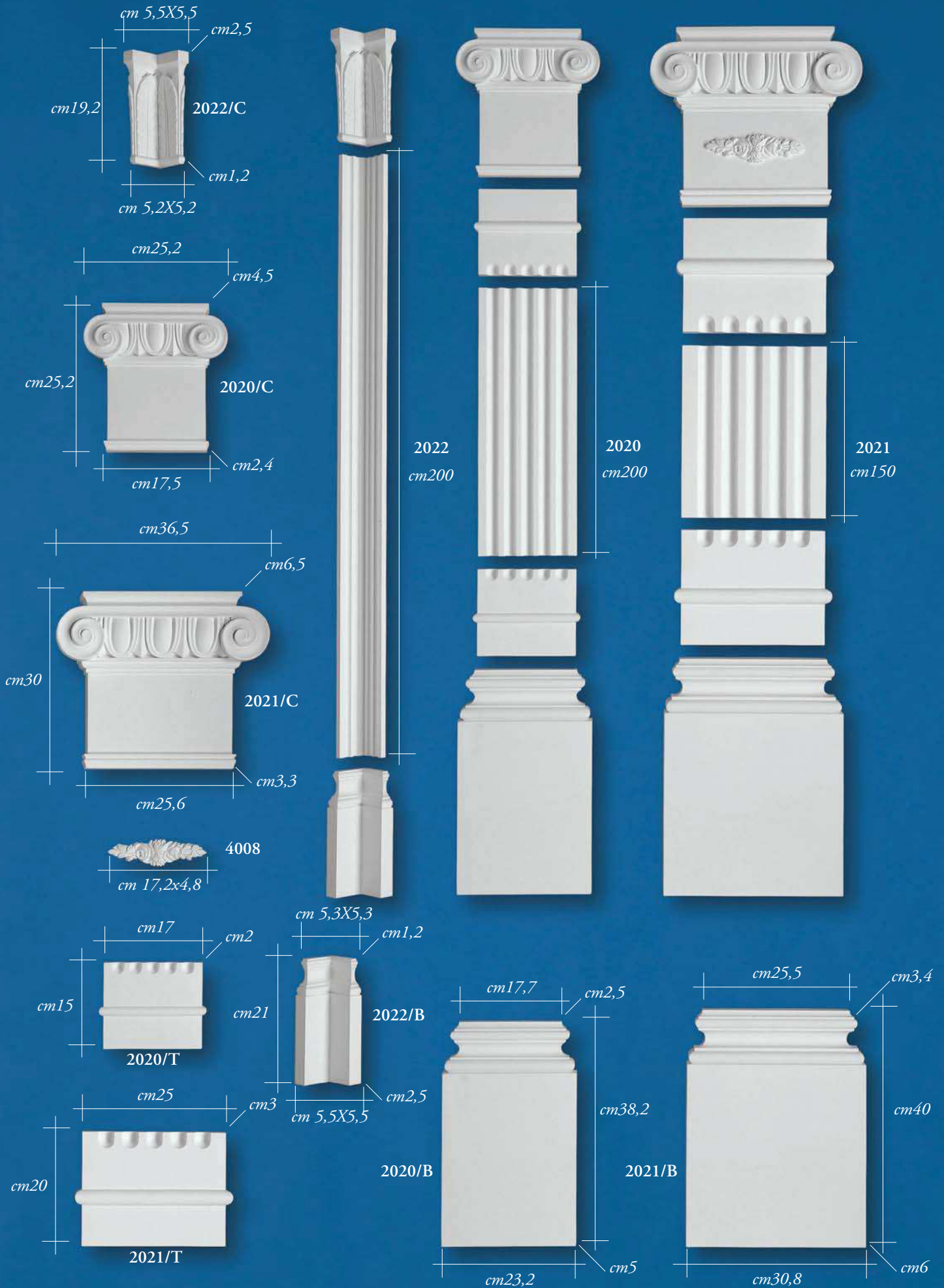

# RIVESTIMENTO PER COLONNE

pilastres • coating for coloumns • säulenverkleidung • kolommen  
SIENŪ PANELĒS

3016

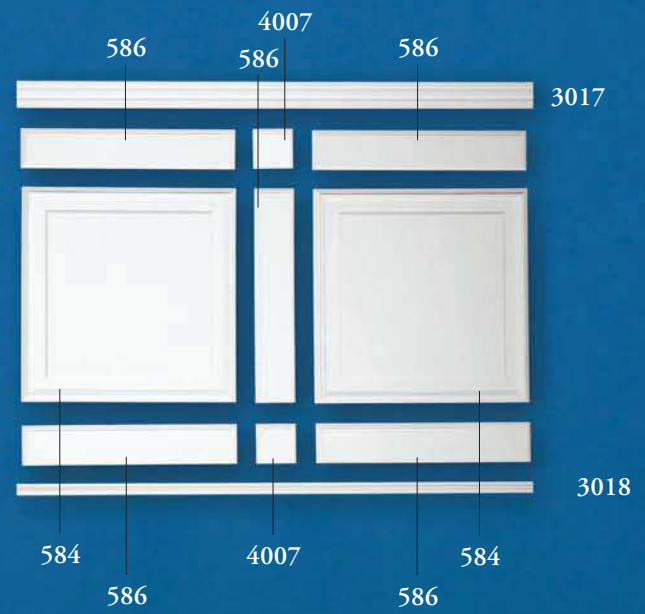
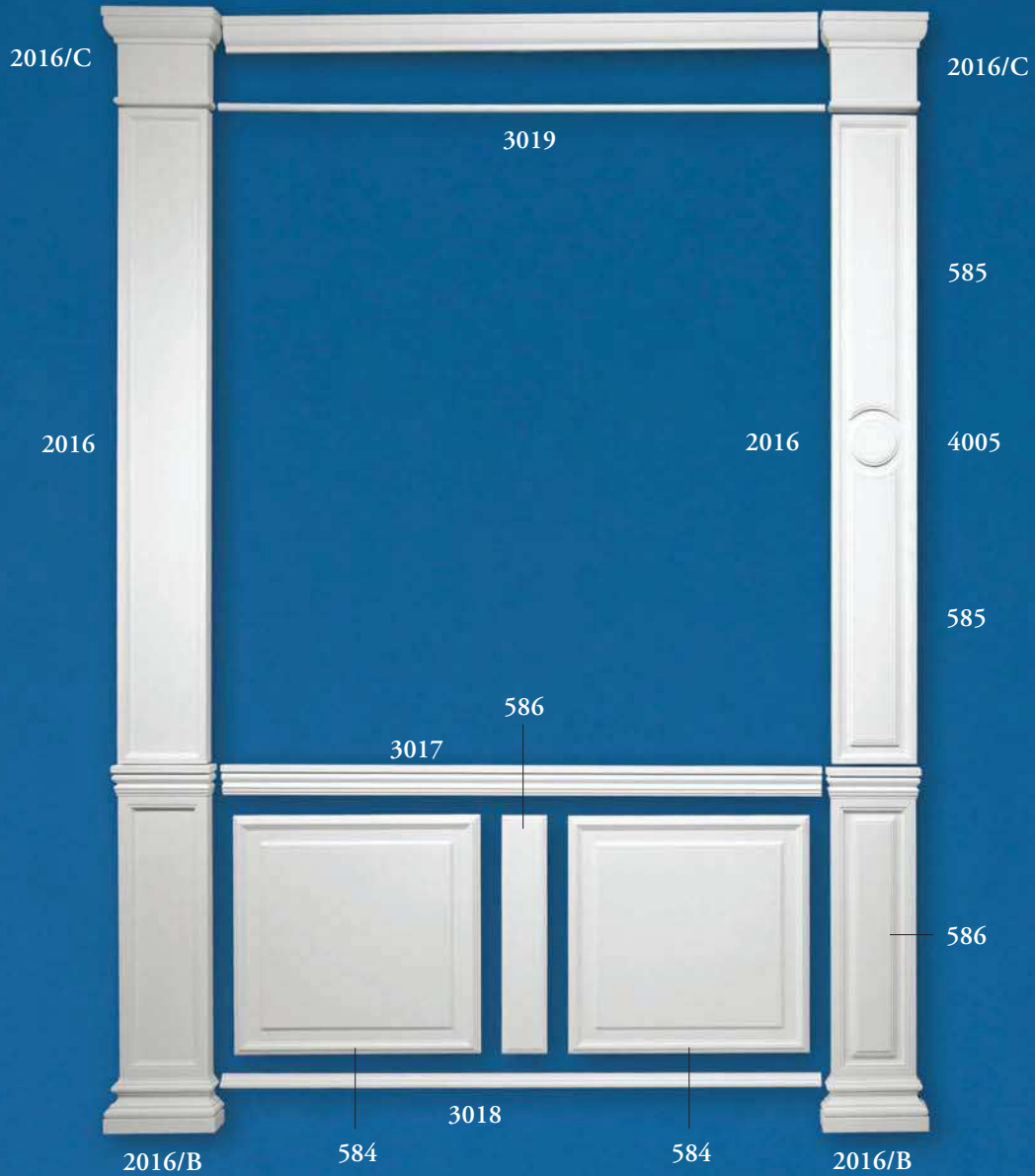







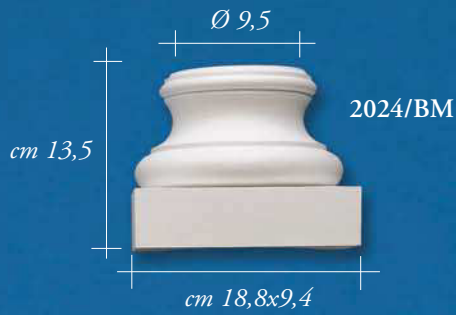
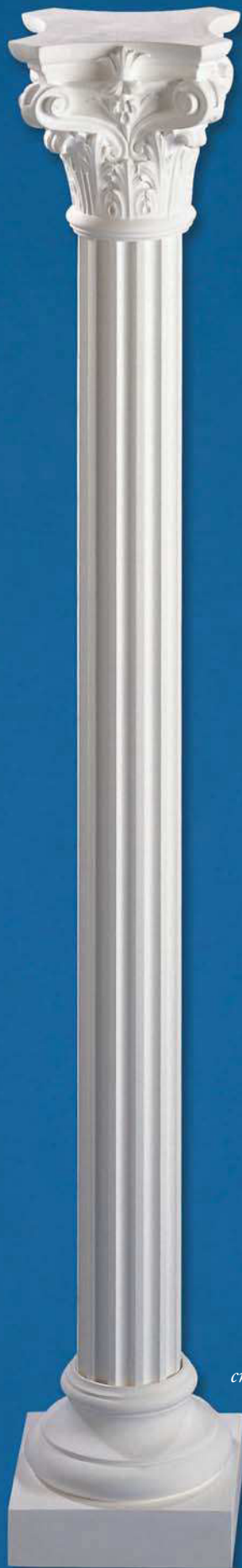





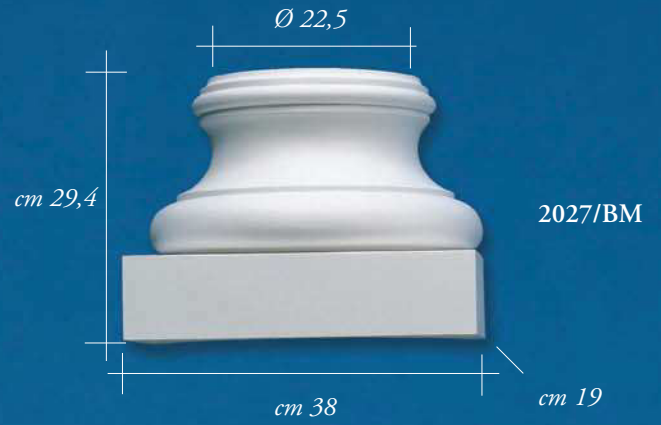

















# RIVESTIMENTO PER CAMINI

habillage chemines • fire surrounds • Kamin • chemines



RIVESTIMENTO PER CAMINI

habillage chemines • fire surrounds • Kamin • chemines



RIVESTIMENTO PER CAMINI  
habillage chemines • fire surrounds • Kamin • chemines











LUBŲ PANELĖS, ORNAMENTAI

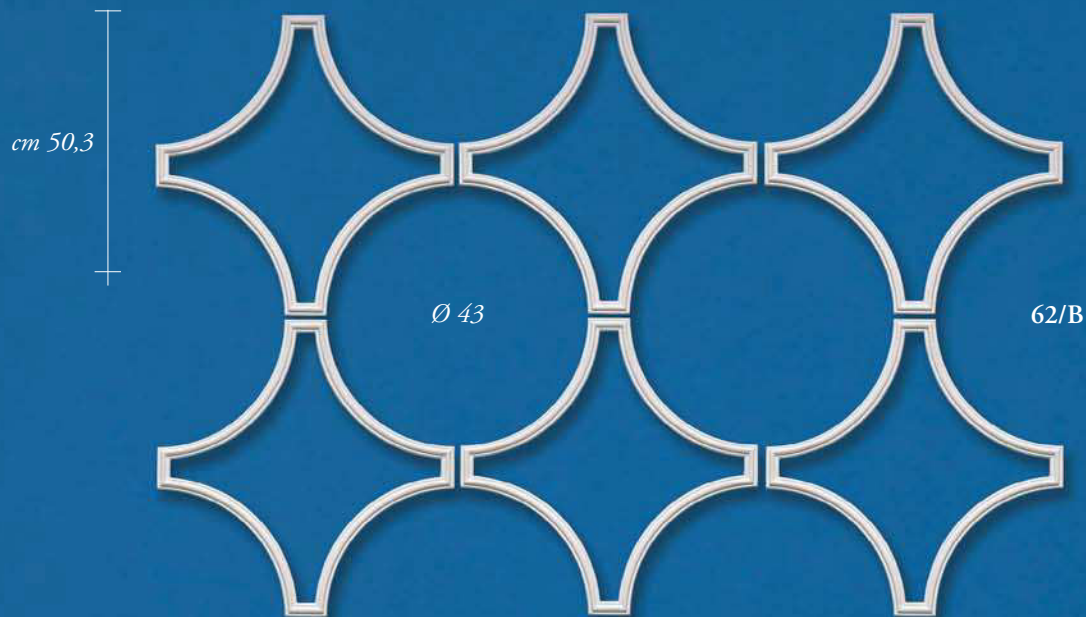



NIŠOS, ORNAMENTAI



542 A cm 67  
B cm 36,5  
C cm 15



562 A cm 56  
B cm 28  
C cm 9,5

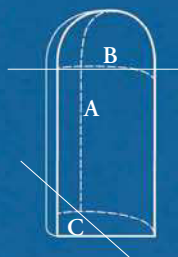

546 A cm 78  
B cm 47  
C cm 22,5



547 A cm 64,5  
B cm 36,5  
C cm 17

PORTALO VIRŠUS, KARŪNA

cm 26

563



cm 107,5

cm 40,5

552



cm 119,5

cm 26,2

5003



cm 3,1

cm 124,2

cm 30,2



5002

cm 137

cm 44,6

565



cm 146





ANGELAI, ANGELIUKAI, PANELĒS, BARELJEFAI



592 cm 56,8x35,5



591 cm 57x31,3



571 cm 57,2x67,5



574 cm 56,2x66,5



570 cm 57,6x67,5



541 cm 59x69

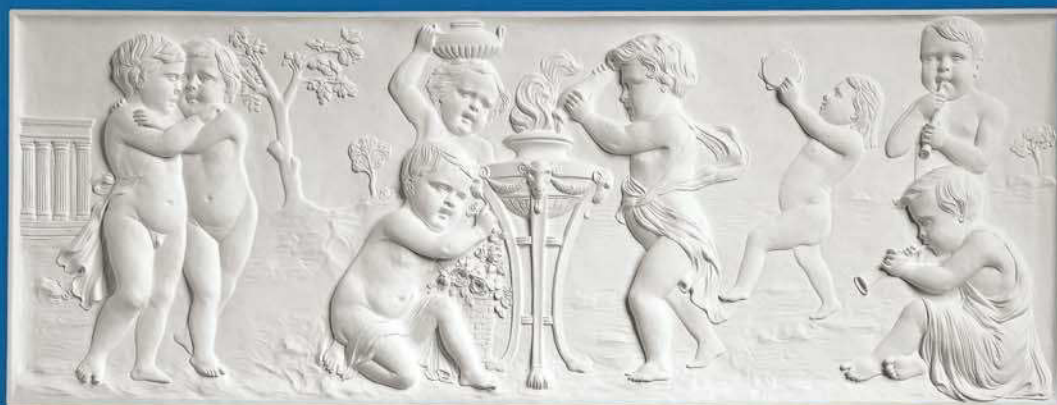

564 cm 53x140



BPN2 Ø 40,2



BPN1 Ø 40,2



573 cm 36,2x26,4



566 cm 46x54



572 cm 36,5x26,8

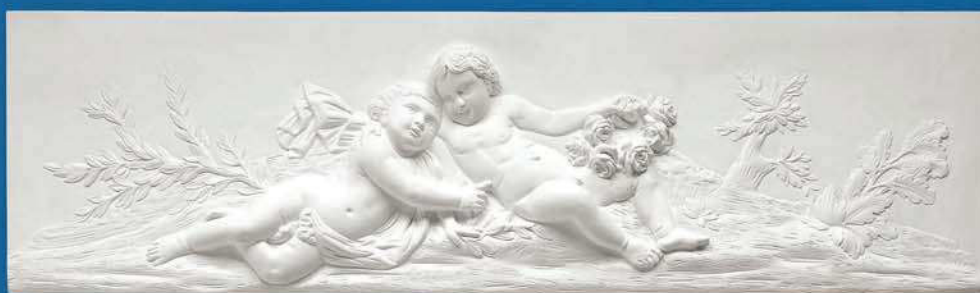

543 cm 34x118



5001 cm 21,6x69





553 cm 38,8x28,5



551 cm 72x51



556 cm 38,8x28,5



554 cm 38,8x28,5



561 Ø 18



560 Ø 18



559 Ø 18



555 cm 38,8x28,5



558 Ø 18



549 cm 81,5x66



550 cm 81,5x66





575 cm 21,8x12



577 cm 27,5x17



576 cm 22x13,5



4010 cm 28,5x18



5000 cm 92,9x56,6

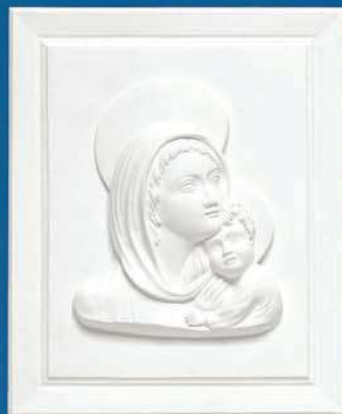

MADONNA cm 43,8x36,2



272/S

cm 12x8,5



272/D

cm 12x8,5



598 cm 43,1x43,1



597 cm 56,6x22,2



599 cm 92,7x56,7



584 cm 56,7x56,7

5006

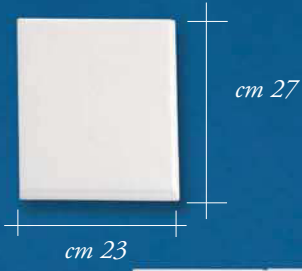

cm 27

5007



5006/S

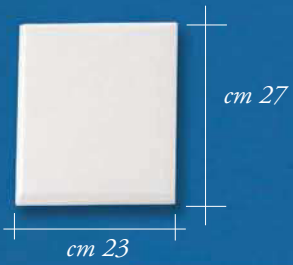

cm 27

5007/S





593 cm 99,5x17,2



594 cm 99,2x27



540 cm 99x31,5





590 cm 43,5x37,2



588 cm 43,5x37,2



578 Ø 45,5



589 cm 43,5x37,2



587 cm 43,5x37,2



544 cm 39x18,5



557 cm 39x18,5



545 cm 39x18,5



595 cm 35,4x90,5



101 cm 24,3x28,2

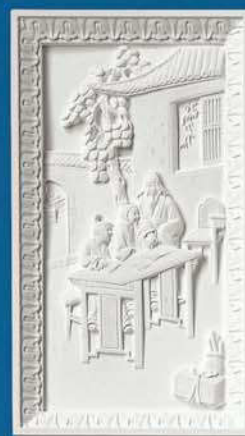

102 cm 32,7x18,5



103 Ø 44

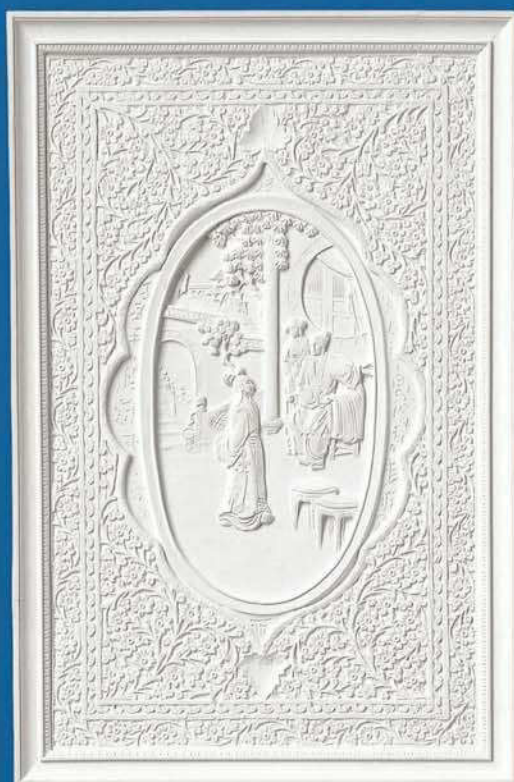

105 cm 60x39,4

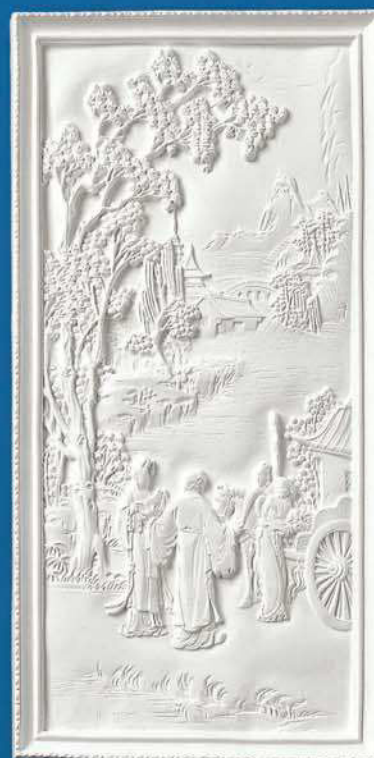

104 cm 58,5x28,6





567 cm 83x120



568 cm 77x128,2



PORTALAI, NIŠOS DURIMS, HERBAI, BARELJEFAI

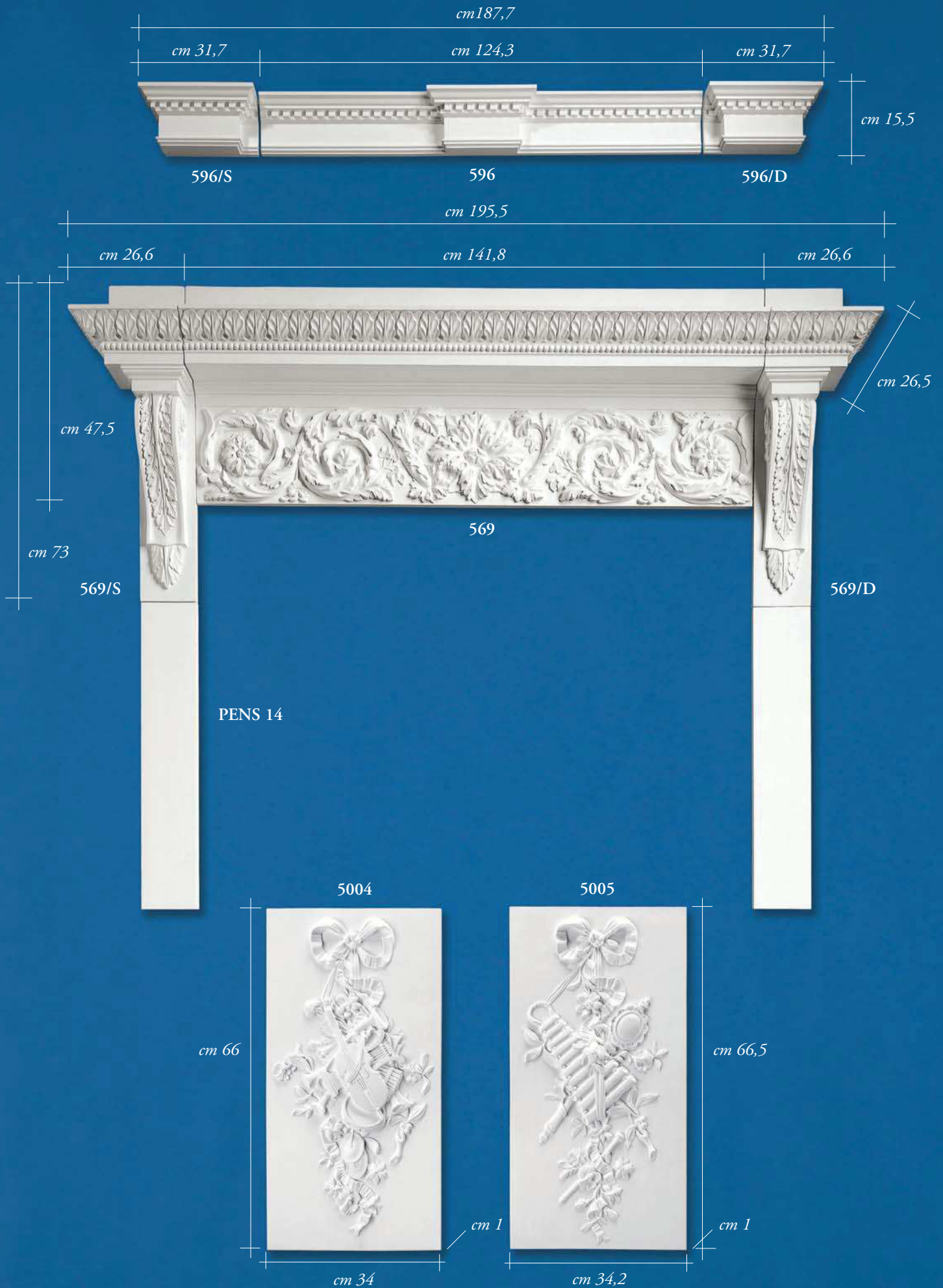

2023/D cm 63x33,1

2023/S cm 63x33,1

2023/D cm 63x33,1

536  
cm 24,3  
cm 6  
cm 19,3

535  
cm 15,1  
cm 6  
cm 10,2

2023 cm 12x9,3

536

3009

3009

535

2023 cm 12x9,3

2023/D cm 63x33,1

2023/S cm 63x33,1

3009

3009

3009

3009

2019

2019

2002 cm 25,5x32

2001/S cm 66,5x68

2001/D cm 66,5x68

750

750

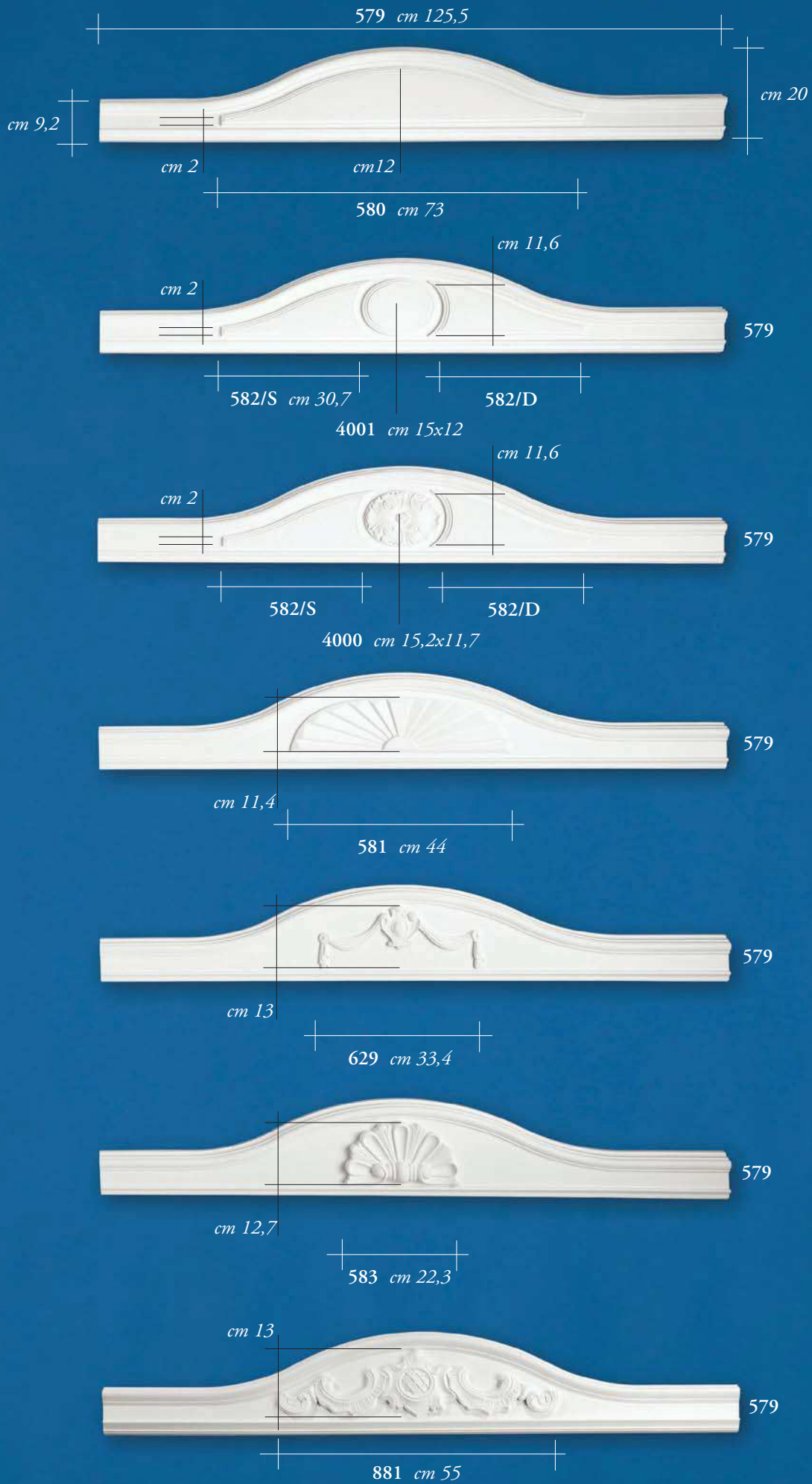



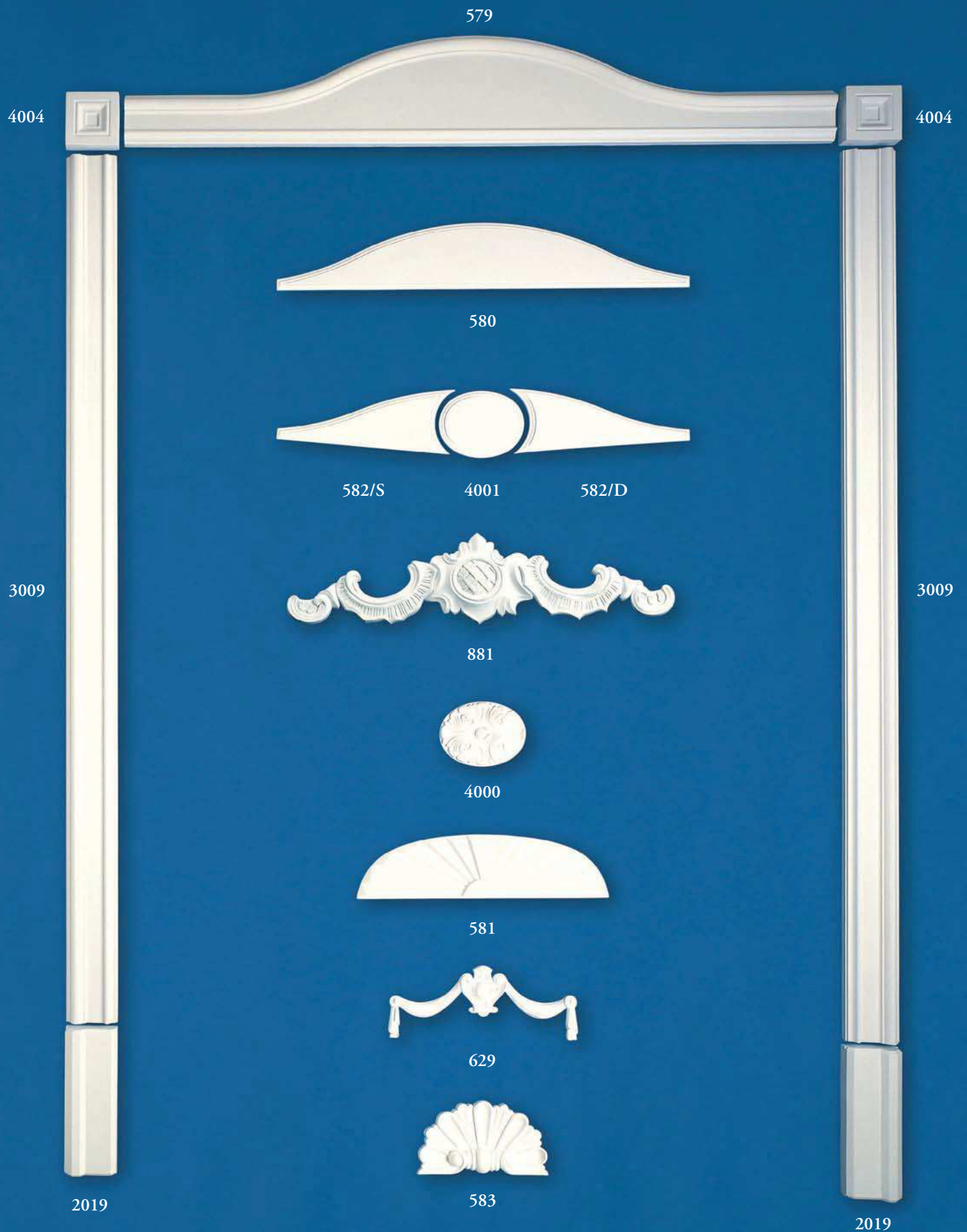

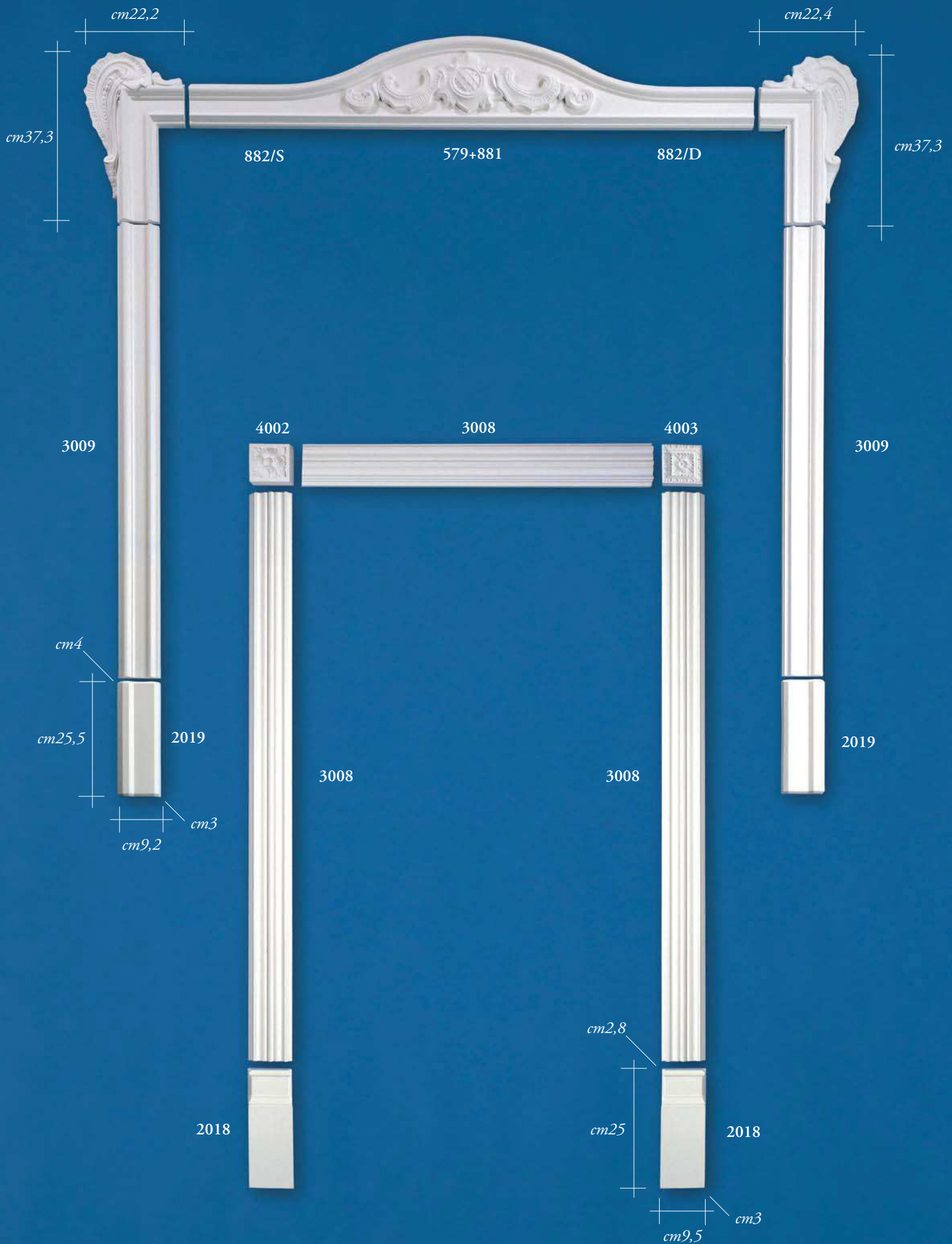

SOFFITTO BAROCCO

mouluures décorative • baroque ceiling • decke im barokstil • baroklijsten

ORNAMENTAI SIENOMS IR LUBOMS

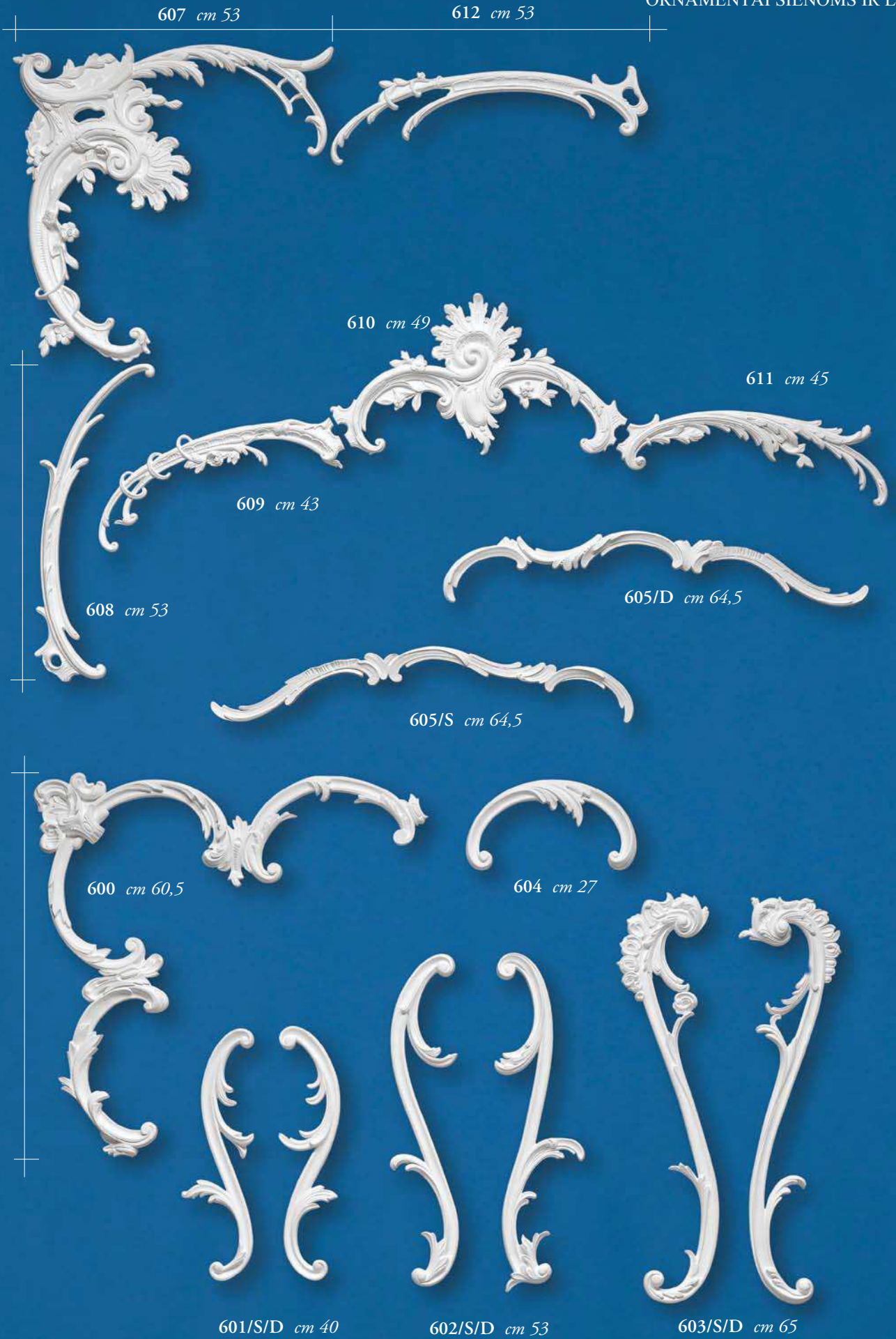



# SOFFITTO BAROCCO

mouluures décorative • baroque ceiling • decke im barokstil • baroklijsten



631 cm 52,5x21

631 cm 52,5x21



632 cm 9,7x32,7



632 cm 9,7x32,7

626 cm 30,3



614 cm 33x 40

627 cm 13x12,5



SOFFITTO BAROCCO

moultures décorative • baroque ceiling • decke im barokstil • baroklijsten

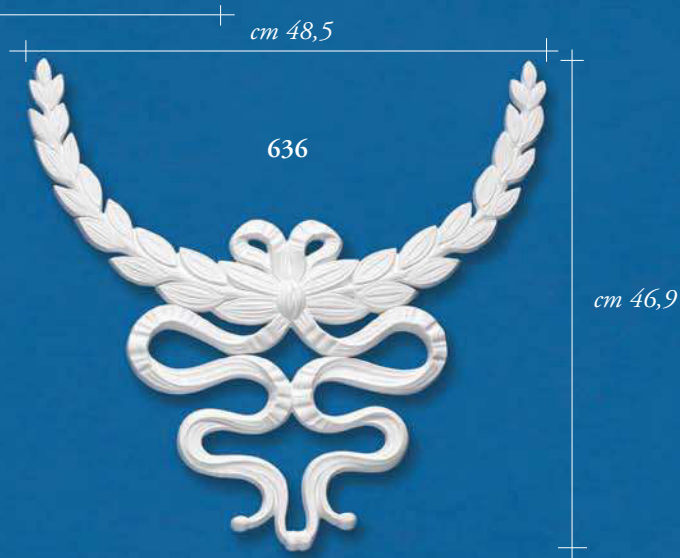
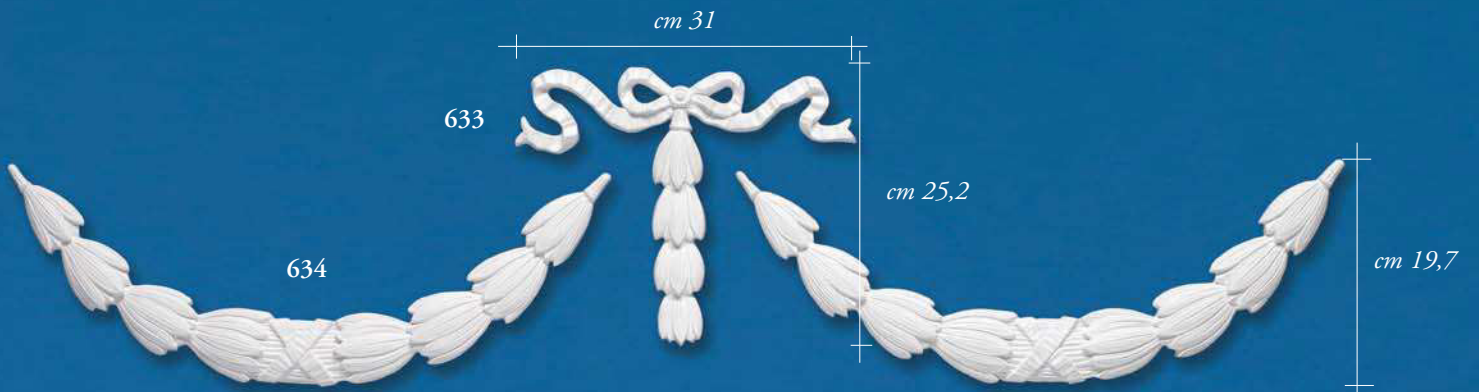



# SOFFITTO BAROCCO

moulures décorative • baroque ceiling • decke im barokstil • baroklijsten

617/S cm 87

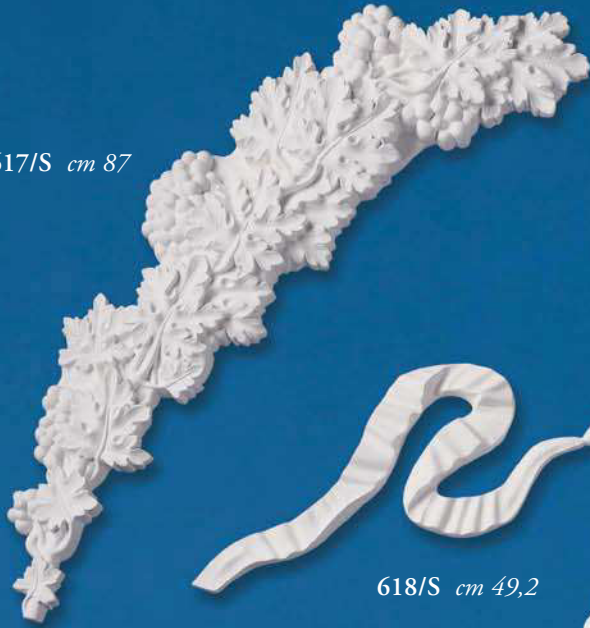

617/D cm 87,6



618/S cm 49,2



618/D cm 48,7



619/S cm 42,9



619/D cm 41,8

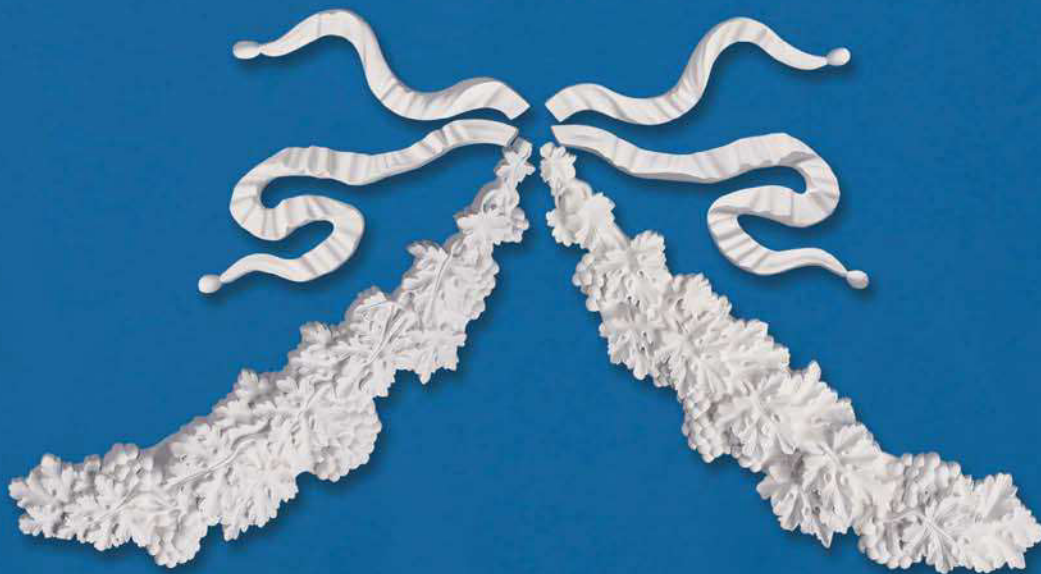









ROZETÈS

misura in cm



63  
63 Ø26



102  
102 cm 21x30



101  
101 Ø27



41  
41 Ø29



440  
440 Ø21



115  
115 Ø30



807  
807 Ø26



37  
37 Ø30



325  
325 Ø31



59  
59 Ø31



439  
439 Ø31



64  
64 Ø30





39  
39 Ø32



405  
405 Ø24



62  
62 Ø32



161  
161 Ø31



304  
304 Ø32



35  
35 Ø32



54  
54 cm 33x24



43  
43 Ø33



303  
303 Ø33





150  
150 Ø33



126  
126 Ø33



158  
158 Ø34



30  
30 Ø36



805  
805 cm 35x26



68  
68 Ø36



42  
42 Ø36



65  
65 Ø34



809  
809 Ø36





402  
402 Ø36,8



34  
34 Ø37



159  
159 cm 37x29



32  
32 Ø37



152  
152 Ø38



324  
324 cm 38x49



318  
318 Ø38



433  
433 Ø38





33 Ø cm 38



315 cm 39x58



38 Ø cm 39



124 Ø cm 40



427 Ø cm 40



944 Ø cm 40,5 / cm 7



920 Ø cm 40

157 cm 40x26



417 Ø cm 40





277 cm 40x28



123 cm 40x30



266 cm 40x30



939 cm 40,1x26,1



305 cm 40x28



432 Ø cm 41



416 Ø cm 40,1



937 Ø cm 40,5





156  
156 Ø41



29  
29 Ø41



58  
58 cm 41x35



148  
148 Ø41



314  
314 Ø42



44  
44 Ø42



401  
401 Ø41,5



307  
307 Ø42





301  
301 Ø42



313  
313 Ø42



36  
36 Ø42



69  
69 Ø42



921  
921 Ø42



808  
808 Ø42



419  
419 Ø43



418  
418 Ø43





153  
153 Ø43



306  
306 Ø43



60  
60 cm 44x23



322  
322 Ø44



414  
414 Ø44,2



317  
317 Ø44



411  
411 Ø44,5



413  
413 Ø45





928  
928 Ø45



28  
28 Ø45



403  
403 cm 45x34



915  
915 Ø45,5



25  
25 Ø46



408  
408 Ø45,6





26  
26 Ø46



27  
27 Ø46



409  
409 Ø47



116  
116 Ø47



425  
425 Ø46,5



428  
428 Ø47





430  
430 Ø47,9



938  
938 Ø49,9



429  
429 cm 48x42



149  
149 Ø49



810  
810 Ø49



327  
327 cm 49x49



316  
316 cm 48x32



61  
61 cm 49x27





913  
913 Ø50



21  
21 Ø50



415  
415 cm 50x35



407  
407 cm 50x45



420  
420 cm 50x37



151  
151 Ø50



112  
112 Ø50



23  
23 Ø50





931  
931 Ø50,2



929  
929 Ø50,5



447  
447 cm 50,3x27,2



423  
423 Ø51,2



434  
434 Ø52



404  
404 cm 52x30



311  
311 Ø52



438  
438 Ø52





146/L  
146/L Ø52



936  
936 cm 53,5x53,5



914  
914 Ø52



448  
448 Ø52,8



113  
113 Ø53



437  
437 Ø53





119 Ø cm 54



22 Ø cm 55



160 Ø cm 56

943 Ø cm 57,8 / cm 10

435 Ø cm 55







207 cm 56x31



49 cm 58x33



308 cm 57x41



24 cm 36x56



48 cm 60x31



421 cm 40x55



422 cm 58,6x42,5



46 cm 59x47





924  
924 Ø 59,2



20  
20 Ø 60



940  
940 cm 60x40



923  
923 Ø 60



927  
927 Ø 60





127  
127 cm 60x42



57  
57 cm 60x53



154  
154 cm 60x42



302  
302 cm 61x45



911  
911 Ø 61



941  
941 Ø 61





47  
47 cm 63x43



436  
436 cm 64,5x45,7



56  
56 cm 64x46



443  
443 Ø 63



99  
99 cm 65x40



309  
309 cm 65x40



45  
45 cm 64x32





243  
243 Ø 66



242  
242 Ø 66



818  
818 Ø 66



930  
930 Ø 66



444  
444 Ø 69





155  
155 cm 65x42



446  
446 cm 67x45



932  
932 Ø 71



323  
323 cm 69x51



51  
51 cm 72x39





905  
905 Ø 73



925  
925 Ø 73,5



431  
431 cm 77,7x53,7



922  
922 Ø 75



909  
909 Ø 78





906  
906 Ø 84



455  
455 cm 81x59



445  
445 cm 83x59



244  
244 cm 85x55





910  
910 Ø 90



606  
606 cm 87x55



52  
52 cm 90x60



901  
901 cm 95x81



904  
904 Ø 95



942  
942 Ø 91





903  
903 cm 99x80



121/L  
121/L Ø 95X62



241  
241 cm 110x75



917  
917 Ø 100



907  
907 Ø 114  
rozetę galima įleisti į lubas





912  
912 Ø 141



908  
908 cm 146x102  
rozetę galima įleisti į lubas



918  
918 Ø 151



902  
902 cm 186x90





PRA39  
PRA39 Ø 39



PRC39  
PRC39 Ø 39



PRE39  
PRE39 Ø 39



PRD39  
PRD39 Ø 39



PRG39  
PRG39 Ø 39



PRS39  
PRS39 Ø 39



PRA52  
PRA52 Ø 52



PRE52  
PRE52 Ø 52



PRD52  
PRD52 Ø 52



PRG52  
PRG52 Ø 52



PRS52  
PRS52 Ø 52



20000 est. Ø cm. 120

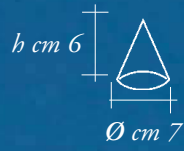



435 Ø int. cm 21,7

435 Ø est. cm 26,5



439 Ø int. cm 25,6

439 Ø est. cm 31



433 Ø int. cm 30

433 Ø est. cm 36,7



2111 Ø int. cm 27,5

2111 Ø est. cm 35



2112 Ø int. cm 31,2

2112 Ø est. cm 40



2102 Ø int. cm 31,7

2102 Ø est. cm 45,3



2108 Ø int. cm 60,3

2108 Ø est. cm 67,8



440 Ø int. cm 55

440 Ø est. cm 59,85



2109 Ø int. cm 47,1

2109 Ø est. cm 60,6



842 Ø int. cm 50,1

842 Ø est. cm 63,5



2103 Ø int. cm 47

2103 Ø est. cm 65,3





843 Ø int. cm 60,2

843 Ø est. cm 66,2



2107 Ø int. cm 50

2107 Ø est. cm 59,6



2104 Ø int. cm 46,8

2104 Ø est. cm 70,3



817 Ø int. cm 55,5

817 Ø est. cm 70,2



2110 Ø int. cm 62,2

2110 Ø est. cm 80,5

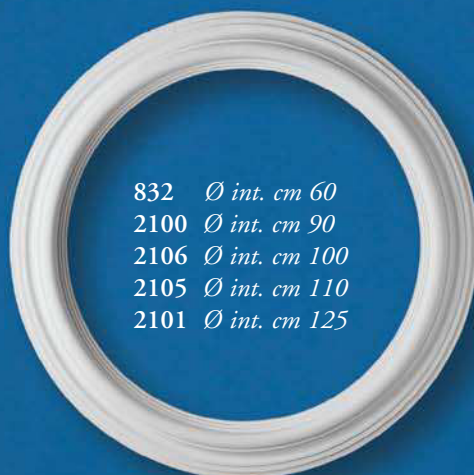

832 Ø int. cm 60  
2100 Ø int. cm 90  
2106 Ø int. cm 100  
2105 Ø int. cm 110  
2101 Ø int. cm 125

832 Ø est. cm 80  
2100 Ø est. cm 110  
2106 Ø est. cm 120  
2105 Ø est. cm 130  
2101 Ø est. cm 145







moules rosaces • composed ceiling roses • ROSONI COMPONENTI

• zusammensetzbare rosetten • samenstellbare rosetten

LUBŪ ORNAMENTAI, ROZETĒS



ROSONI COMPONENTI • moulures rosaces • composed ceiling roses

• zusammensetzbare rosetten • samenstellbare rosezetten

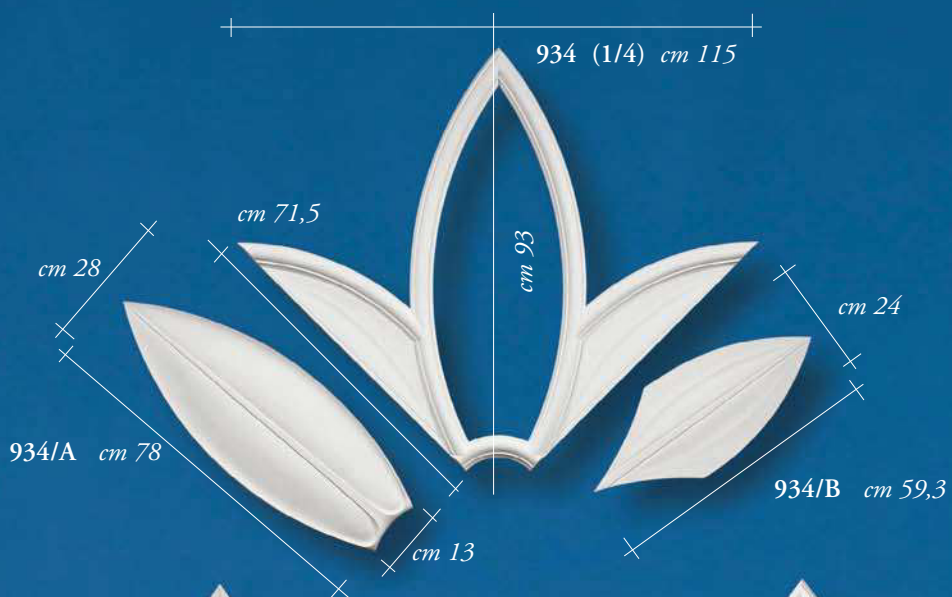

934/A (4Pz.)  
+934/B (4Pz.)  
cm 169,4

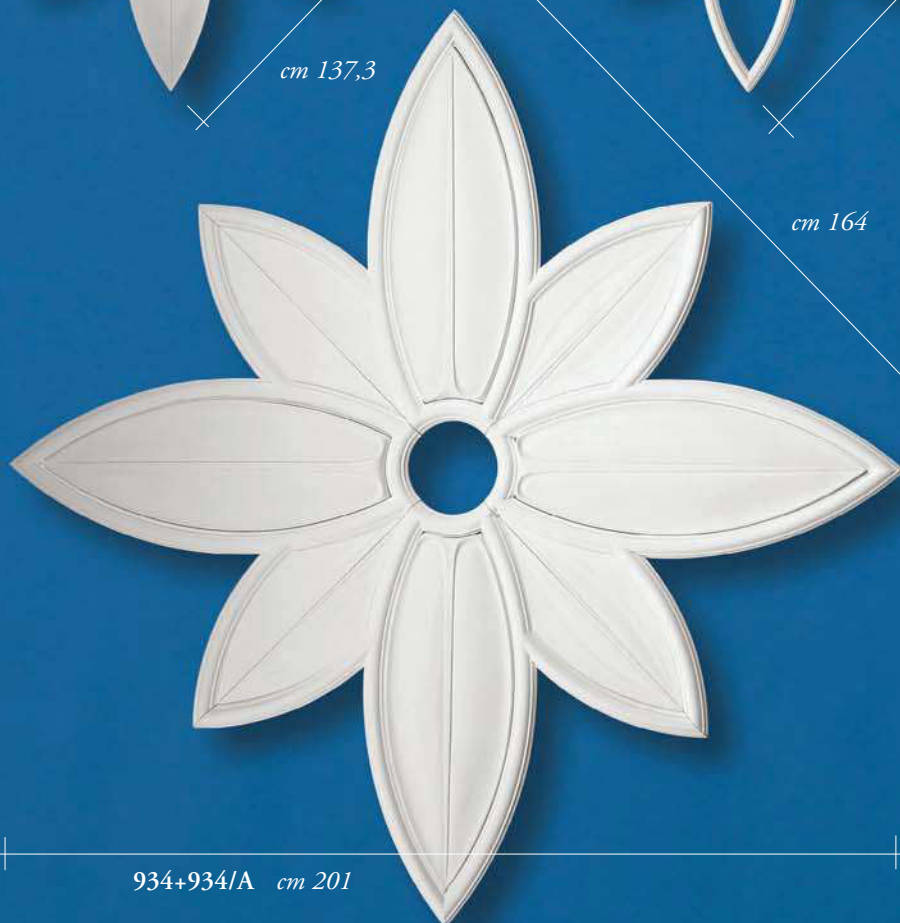



926 cm 191



Ø int. cm 44,7

926/C cm 31



Ø cm 109,5

cm 93

926/B Ø est. cm 62,7

926/A cm 37,5



cm 61

926/D cm 46



508 cm35



510 cm 35



512 cm 52



263 cm 50



258 cm 49





GĒLĒS, MAŽOS ROZETĒS



326/B Ø cm 4,5



105 Ø cm 6



106 Ø cm 6



108 Ø cm 6



109 Ø cm 6



443 Ø cm 6



111 Ø cm 6



120 Ø cm 8



107 Ø cm 7



110 Ø cm 6



PR8 Ø cm 8



437 Ø cm 8



351 Ø cm 9



805 Ø cm 9



4011 cm 5x5

cm 2



821 Ø cm 9



354 Ø cm 9,5



436 Ø cm 11



352 Ø cm 9,5



125 Ø cm 19



50 Ø cm 19



53 Ø cm 20





4002 cm 9,7x9,7



4006 cm 11,5x11,5



4003 cm 9x9



4004 cm 9,7x9,7



4001 cm 15x12



4007 cm 10,5x10,5



104 cm 11x11



4005 Ø cm 11,5



146 cm 12x12



143 Ø cm 11



4000 cm 15,2x11,7



76 Ø cm 12



237 Ø cm 19,5



238 Ø cm 16,5



67 Ø cm 20



130 Ø cm 20



141 Ø cm 13



441 Ø cm 15,8



82 Ø cm 13



72 Ø cm 14



4009 cm 39,8x6,3



273 Ø cm 15



71 Ø cm 15,4



79 Ø cm 15



355 Ø cm 15



263 T..G.



353 Ø cm 16

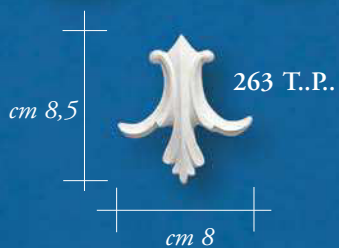

263 T..P.



55 cm 25x20



4008 cm 17,2x4,8



114 cm 25x15





129 Ø cm 15,5



131 Ø cm 15,5



142 Ø cm 16,5



139 Ø cm 16,3



128 Ø cm 16



cm 22,2

4012 cm 23



132 Ø cm 18,5



247 Ø cm 23,5



133 Ø cm 18









245 cm 67x43



4501 cm 81,5x95,5



202 cm 53,2x32



201 cm 36x30



4500 cm 62,5x83



507 cm 63x44





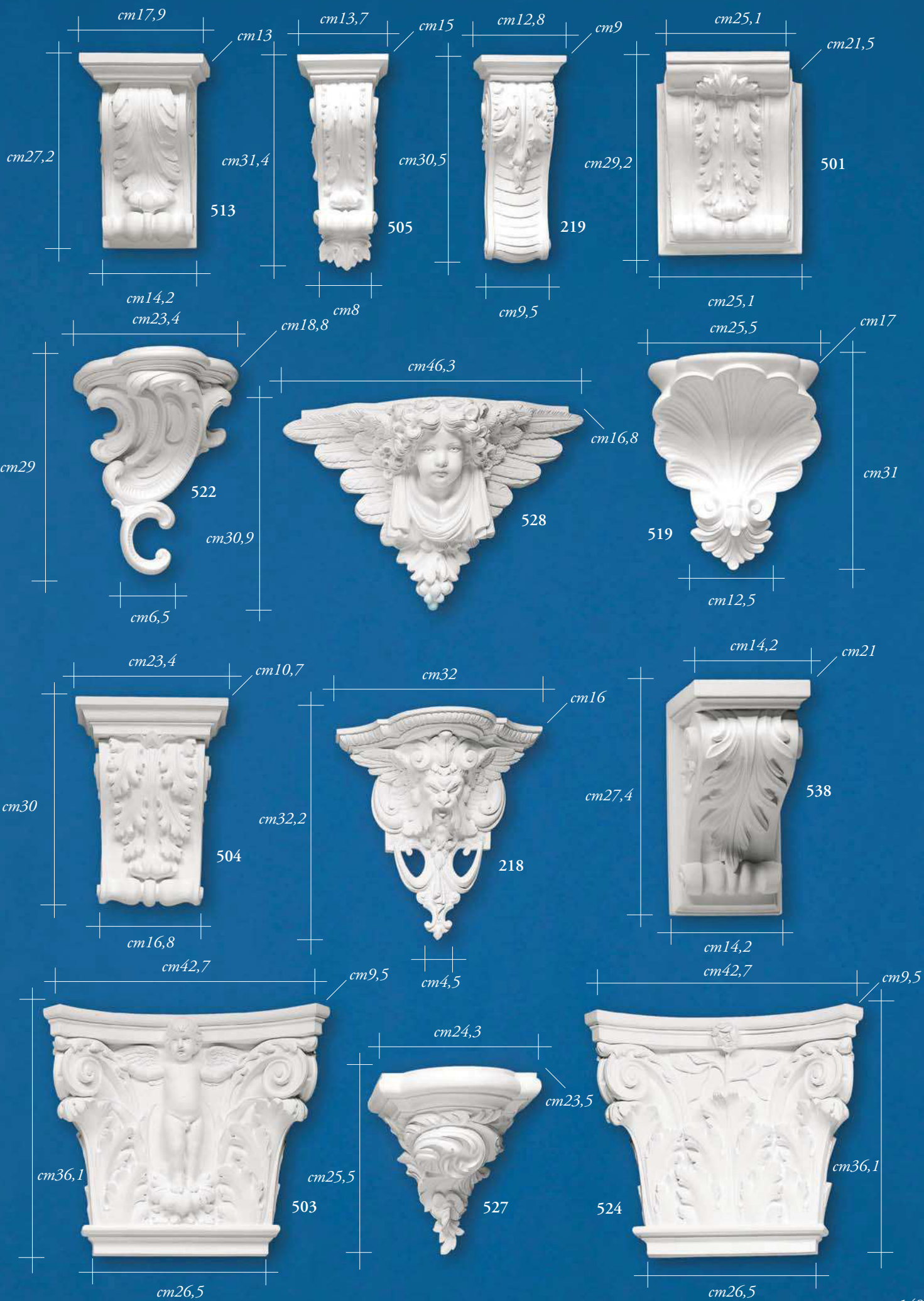











CORNICI		puslapis		kodus		puslapis		PENSILINE		puslapis		kodus		puslapis		kodus		puslapis	
kodas	artikolo	artikolo	pagina	artikolo	pagina	artikolo	pagina	artikolo	artikolo	artikolo	pagina	artikolo	artikolo	artikolo	pagina	artikolo	artikolo	artikolo	pagina
BC. 1/B	10	BC. 288	4	BC. 786	10	PENS 5	16	BS. 785	20	BMAN 14	28								
BC. 2/B	10	BC. 289	5	BC. 787	9	PENS 10	16	BS. 799	22	BMAN 16	28								
BC. 20/D	4	BC. 290	10	BC. 788	6	PENS 14	16/90	BS. 3000	18	BMAN 18	28								
BC. 21/C	9	BC. 291	4	BC. 789	4	PENS 18	16	BS. 3014	18	BMAN 20	28								
BC. 23/B	6	BC. 292	6	BC. 790	5			BS. 3015	18										
BC. 23/C	4	BC. 293	3	BC. 791	3	<b>SGUSCIONI</b>		BS. 3023	17	<b>ANGOLI</b>									
BC. 24/B	5	BC. 296	10	BC. 792	9	artikolo	pagina	BS. 3026	25	artikolo	pagina								
BC. 24/C	6	BC. 299	4	BC. 793	8	BS. 8/S	25	BS. 3027	17	BA 3/A	38								
BC. 27/B	6	BC. 300	10	BC. 794	9	BS. 9/S	25	BS. 3028	18	BA 6/A	34								
BC. 28/C	5	BC. 306/D	4	BC. 795	12	BS. 201	17	BS. 3031	19	BA 13/A	39								
BC. 35/B	6	BC. 310/D	10	BC. 796	11	BS. 202	17	BS. 3033	22	BA. 70	42								
BC. 36/B	4	BC. 700	3	BC. 797	12	BS. 203	17	BS. 3034	22	BA. 74	41								
BC. 37/B	10	BC. 701	7	BC. 798	11	BS. 204	17	BS. 3039	19	BA. 77	37								
BC. 38/B	5	BC. 702	5	BC. 3001	9	BS. 294	19	BS. 3044	21	BA. 81	36								
BC. 41/B	3	BC. 703	14	BC. 3002	9	BS. 295	19	BS. 3046	21	BA. 84	42								
BC. 41/C	3	BC. 704	6	BC. 3003	8	BS. 295/B	19	BS. 3047	26	BA. 85	36								
BC. 46/B	5	BC. 705	11	BC. 3004	13	BS. 297	22	BS. 3048	24	BA. 88	42								
BC. 46/D	3	BC. 706	7	BC. 3005	14	BS. 298	17	BS. 3049	17	BA. 89	40								
BC. 48/A	6	BC. 707	6	BC. 3006	14	BS. 298/B	18	BS. 3050	17	BA. 90	40								
BC. 49/A	9	BC. 708	12	BC. 3007	11	BS. 710	23	BS. 3052	20	BA. 91	36								
BC. 49/B	4	BC. 709	12	BC. 3008	12	BS. 711	19	BS. 3054	20	BA. 92	33								
BC. 49/C	8	BC. 715	8	BC. 3009	12	BS. 712	20	BS. 3055	19	BA. 93	33								
BC. 50/B	7	BC. 720	3	BC. 3010	14	BS. 713	20	BS. 3056	19	BA. 94	34								
BC. 52/B	3	BC. 721	4	BC. 3011	15	BS. 714	23	BS. 3057	18	BA. 95	40								
BC. 53/B	10	BC. 722	10	BC. 3012	13	BS. 715/S	19	BS. 3059	23	BA. 96	36								
BC. 54/B	11	BC. 723	13	BC. 3013	5	BS. 716	20	BS. 3062	24	BA. 97	34								
BC. 55/B	7	BC. 724	12	BC. 3016	10/61	BS. 717	17	BS. 3063	26	BA. 98	40								
BC. 56/B	7	BC. 726	11	BC. 3017	10/61	BS. 718	18	BS. 3064	26	BA. 99	40								
BC. 57/B	6	BC. 727	11	BC. 3018	4/61	BS. 719	19	BS. 3065	26	BA. 101/L	47								
BC. 60/B	4	BC. 732	9	BC. 3019	3/61	BS. 725	17	BS. 3066	26	BA. 102/L	44								
BC. 61/B	4	BC. 735	3	BC. 3020	7	BS. 728	23	BS. 3067	26	BA. 118	33								
BC. 62/B	3	BC. 737	6	BC. 3021	11	BS. 729	25	BS. 3070	24	BA. 121	36								
BC. 63/B	7	BC. 738	12	BC. 3022	8	BS. 730	22	BS. 3071	26	BA. 134	34								
BC. 64/B	11	BC. 740	5	BC. 3024	9	BS. 731	22	BS. 3072	23	BA. 135	41								
BC. 65/B	6	BC. 747	14	BC. 3025	12	BS. 733	20	BS. 3073	23	BA. 136	36								
BC. 66/B	6	BC. 748	14	BC. 3029	3	BS. 734	17	BS. 3074	25	BA. 137	36								
BC. 68/B	5	BC. 749	15	BC. 3030	8	BS. 736	26	BS. 3075	24	BA. 147	39								
BC. 208	8	BC. 750	15	BC. 3032	14	BS. 739	25	BS. 3076	24	BA. 206	33								
BC. 209	9	BC. 752	10	BC. 3035	13	BS. 741	17	PCA 0200	27	BA. 220	40								
BC. 210	7	BC. 753	4	BC. 3036	13	BS. 742	18	PCD 0200	27	BA. 222	40								
BC. 211	8	BC. 754	6	BC. 3037	9	BS. 743	20	PCE 0200	27	BA. 223	37								
BC. 240	9	BC. 758	7	BC. 3038	7	BS. 744	19	PCG 0200	27	BA. 225	40								
BC. 253	10	BC. 759	11	BC. 3040	9	BS. 745	18	PCS 0200	27	BA. 229	41								
BC. 254	7	BC. 763	15	BC. 3041	11	BS. 746	17			BA. 230	42								
BC. 255	5	BC. 766	13	BC. 3042	13	BS. 751	23	<b>GOLE</b>		BA. 231	42								
BC. 262	12	BC. 767	14	BC. 3043	12	BS. 755	19	artikolo	pagina	BA. 232	40								
BC. 265	9	BC. 768	12	BC. 3051	14	BS. 756	18	BG. 3	27	BA. 233	36								
BC. 275	13	BC. 771	8	BC. 3053	13	BS. 757	18	BG. 5	27	BA. 234	33								
BC. 276	7	BC. 772	8	BC. 3058	15	BS. 760	20	BG. 7	27	BA. 235	33								
BC. 277	5	BC. 774	15	BC. 3060	14	BS. 761	17	BG. 10	27	BA. 246	39								
BC. 278	8	BC. 775	15	BC. 3061	15	BS. 762	18	BG. 15	27	BA. 251	39								
BC. 279	11	BC. 776	8	BC. 3068	15	BS. 764	22	BG. 20	27	BA. 257	41								
BC. 280	12	BC. 777	8	BC. 3069	13	BS. 765	22			BA. 259	41								
BC. 281	14	BC. 778	12	BC. 3077	3	BS. 769	18	<b>MANTOVANE</b>		BA. 260	36								
BC. 282	11	BC. 779	5	BC. 3078	13	BS. 770	18	artikolo	pagina	BA. 261	34								
BC. 283	7	BC. 780	7	BC. 3079	13	BS. 773	19	BMAN 8	28	BA. 267	41								
BC. 284	5	BC. 782	15			BS. 781	24	BMAN 10	28	BA. 268	39								
BC. 285	3	BC. 784	11			BS. 783	20	BMAN 12	28	BA. 269	38								

ANGOLI		puslapis		kudas		puslapis		kudas		puslapis		kudas		puslapis		kudas		puslapis	
kodas	articulo	articulo	pagina	articulo	pagina	articulo	pagina	articulo	pagina	articulo	pagina	articulo	pagina	articulo	pagina	articulo	pagina	articulo	pagina
BA. 270	38	BA. 846	38	BA. 6010	43	BAM 881	93	BCR 6/B	56/57	BCR 2025	67								
BA. 271	37	BA. 847	35	BA. 6011	43	BAM 6008	36	BCR 7	56/57	BCR 2025/A	67								
BA. 401	36	BA. 848	32	BA. 6012	43	BAM 6023	45	BCR 7/A	56	BCR 2025/B	67								
BA. 403	33	BA. 849	41	BA. 6013	43	BAM 6027	45	BCR 8	56	BCR 2025/BM	67								
BA. 404	36	BA. 851	34	BA. 6014	43			BCR 9	56	BCR 2025/C	67								
BA. 405	42	BA. 852	35	BA. 6015	43			BCR 11/BA	66	BCR 2025/CDOR	67								
BA. 406	37	BA. 853	35	BA. 6016	43	<b>DIFFUSORI LUCE</b>		BCR 12	56	BCR 2025/CM	67								
BA. 407	42	BA. 854	35	BA. 6017	43	articulo	pagina	BCR 13	56	BCR 2025/CMDOR	67								
BA. 408	41	BA. 855/S	35	BA. 6018	43	BDL 1/S	50	BCR 14	56	BCR 2025/D	67								
BA. 409	41	BA. 856/D	35	BA. 6019	45	BDL 2/S	50	BCR 15	56	BCR 2026	62								
BA. 410	38	BA. 857	39	BA. 6020	45	BDL 4/S	50	BCR 16/B	62	BCR 2026/B	62								
BA. 411	38	BA. 858	39	BA. 6021	45	BDL 6/S	50	BCR 17	68	BCR 2026/BM	62								
BA. 412	50	BA. 859	39	BA. 6024	32	BDL 6/SA	49	BCR 18	68	BCR 2026/C	62								
BA. 413	42	BA. 862	35	BA. 6025	32	BDL 11/S	50	BCR 2001/D	91	BCR 2026/CDOR	62								
BA. 414	36	BA. 863	35	BA. 6026	45	BDL 12/S	49	BCR 2001/S	91	BCR 2026/CM	62								
BA. 415	50	BA. 865	33	BA. 6028	45	BDL 13/S	49	BCR 2002	91	BCR 2026/CMDOR	62								
BA. 417	34	BA. 866	33			BDL 14/S	49	BCR 2003	63	BCR 2027	65								
BA. 418	39	BA. 867	33	<b>ANGOLI LIBERI</b>		BDL 15/S	50	BCR 2003/B	63	BCR 2027/B	65								
BA. 419	50	BA. 868	33	articulo	pagina	BDL 19	51	BCR 2004	58	BCR 2027/BM	66								
BA. 420	50	BA. 869	33	BAL 73	46	BDL 138	51	BCR 2004/B	58	BCR 2027/C	65								
BA. 421	41	BA. 870	35	BAL 75	46	BDL 140	51	BCR 2004/C	58	BCR 2027/CDOR	66								
BA. 422	50	BA. 871	34	BAL 78	46	BDL 416	51	BCR 2005	56/57	BCR 2027/CM	66								
BA. 423	50	BA. 872	34	BAL 83	46	BDL 1000	51	BCR 2006	56	BCR 2027/CMDOR	66								
BA. 424	33	BA. 873	31	BAL 100	46	BDL 1001	51	BCR 2007	56	BCR 2028	65								
BA. 427	39	BA. 874	31	BAL 103	46	BDL 1002	51	BCR 2008	56	BCR 2029	62								
BA. 428	50	BA. 875	35	BAL 144	46	BDL 1003	53	BCR 2009	56	BCR 2030	55								
BA. 429	50	BA. 876	40	BAL 145	46	BDL 1004	53	BCR 2010	56	BCR 2030/B	55								
BA. 430	34	BA. 877	37	BAL 224	46	BDL 1005	53	BCR 2011	68	BCR 2030/B1	55								
BA. 431	39	BA. 879	37	BAL 227	46	BDL 1006	53	BCR 2015	68	BCR 2030/C	55								
BA. 432	38	BA. 882/D	94	BAL 228	46	BDL 1007	53	BCR 2016	59/61	BCR 2030/C1	55								
BA. 434	35	BA. 882/S	94	BAL 249	46	BDL 1008	52	BCR 2016/B	59/61	BCR 2030/T	55								
BA. 441	42	BA. 883	36	BAL 426	46	BDL 1009	52	BCR 2016/C	59/61										
BA. 442	42	BA. 884	49	BAL 850	36	BDL 1010	52	BCR 2017	8/59										
BA. 443	33	BA. 885	49	BAL 864	47	BDL 1011	53	BCR 2017/B	59										
BA. 804	34	BA. 886	32	BAL 892	47	BDL 1012	53	BCR 2017/C	59										
BA. 813	39	BA. 887	32	BAL 6022	47	BDL 1013	53	BCR 2018	94										
BA. 814	32	BA. 888	32			BDL 1014	53	BCR 2019	91/93/94	<b>RIVESTIMENTO</b>									
BA. 816	37	BA. 889	32	<b>ANGOLI E MEZZERIE</b>		BDL 1015	52	BCR 2020	57/60	<b>PER CAMINI</b>									
BA. 819	38	BA. 890	32	articulo	pagina	BDL 1016	52	BCR 2020/B	60	articulo	pagina								
BA. 820	34	BA. 891	32	BAM 205	33	BDL 1017	52	BCR 2020/C	60	BRC 651/C	71								
BA. 822	38	BA. 893	49	BAM 212	41	BDL 1018	53	BCR 2020/T	60	BRC 652/C	71								
BA. 823	39	BA. 894	49	BAM 213	41	BDL 1019	52	BCR 2021	57/60	BRC 653/C	72								
BA. 824	40	BA. 895	31	BAM 214	41	BDL 1020	52	BCR 2021/B	60	BRC 654/C	72								
BA. 825	40	BA. 896	31	BAM 215	41	BDL 1021	52	BCR 2021/C	60	BRC 655/C	73								
BA. 826	42	BA. 897	31	BAM 216	41	BDL 1022	52	BCR 2021/T	60	BRC 656/C	73								
BA. 827	34	BA. 898	31	BAM 217	41	BDL 1023	53	BCR 2022	57/60	BRC 657/C	74								
BA. 828	38	BA. 899	31	BAM 226	41	BDL 1024	53	BCR 2022/B	60										
BA. 833	44	BA. 900	31	BAM 252	39	BDL 1025	53	BCR 2022/C	60										
BA. 834/S	35	BA. 3066/A	26	BAM 425	33			BCR 2023	91										
BA. 835/D	35	BA. 6000	31	BAM 800	46	<b>COLONNE</b>		BCR 2023/D	91										
BA. 836	44	BA. 6001	31	BAM 801	46	<b>E RIVESTIMENTI</b>		BCR 2023/S	91	<b>CASSETTONATO</b>									
BA. 837	50	BA. 6002	31	BAM 802	41	articulo	pagina	BCR 2024	64	articulo	pagina								
BA. 838	50	BA. 6003	31	BAM 860	35	BCR 4	56/57	BCR 2024/B	64	BCA 62/B	77								
BA. 839	38	BA. 6004	32	BAM 861	37	BCR 4/A	56	BCR 2024/BM	64	BCA 650	77								
BA. 840	45	BA. 6005	32	BAM 878	37	BCR 5	56/57	BCR 2024/C	64	BCA 803	77								
BA. 841	44	BA. 6006	31	BAM 880	37	BCR 5/A	56	BCR 2024/CDOR	64	BCA 6600	77								
BA. 844	42	BA. 6007	31			BCR 6	56/57	BCR 2024/CM	64										
BA. 845	42	BA. 6009	42					BCR 2024/CMDOR	64										



PANNELLI		puslapis		SOFFITTO BAROCCO		ROSONI		puslapis		puslapis	
kodas	articulo	articulo	pagina	kodas	articulo	kodas	articulo	articulo	pagina	articulo	pagina
BP. 1	82	BP. 592	81	BSB 600	95	BR. 20	118	BR. 149	112	BR. 421	117
BP. 2	82	BP. 593	86	BSB 601/D	95	BR. 21	113	BR. 150	103	BR. 422	117
BP. 101	88	BP. 594	86	BSB 601/S	95	BR. 22	116	BR. 151	113	BR. 423	114
BP. 102	88	BP. 595	87	BSB 602/D	95	BR. 23	113	BR. 152	104	BR. 425	111
BP. 103	88	BP. 596	90	BSB 602/S	95	BR. 24	117	BR. 153	109	BR. 427	105
BP. 104	88	BP. 596/D	90	BSB 603/D	95	BR. 25	110	BR. 154	119	BR. 428	111
BP. 105	88	BP. 596/S	90	BSB 603/S	95	BR. 26	111	BR. 155	122	BR. 429	112
BP. 540	86	BP. 597	84	BSB 604	95	BR. 27	111	BR. 156	107	BR. 430	112
BP. 541	81	BP. 598	84	BSB 605/D	95	BR. 28	110	BR. 157	105	BR. 431	123
BP. 542	78	BP. 599	84	BSB 605/S	95	BR. 29	107	BR. 158	103	BR. 432	106
BP. 543	82	BP. 5000	84	BSB 607	95	BR. 30	103	BR. 159	104	BR. 433	104
BP. 544	87	BP. 5001	82	BSB 608	95	BR. 32	104	BR. 160	116	BR. 434	114
BP. 545	87	BP. 5002	79	BSB 609	95	BR. 33	105	BR. 161	102	BR. 435	116
BP. 546	78	BP. 5003	79	BSB 610	95	BR. 34	104	BR. 207	117	BR. 436	120
BP. 547	78	BP. 5004	90	BSB 611	95	BR. 35	102	BR. 241	127	BR. 437	115
BP. 549	83	BP. 5005	90	BSB 612	95	BR. 36	108	BR. 242	121	BR. 438	114
BP. 550	83	BP. 5006	85	BSB 613	96	BR. 37	101	BR. 243	121	BR. 439	101
BP. 551	83	BP. 5006/S	85	BSB 614	96	BR. 38	105	BR. 244	124	BR. 440	101
BP. 552	79	BP. 5007	85	BSB 615	96	BR. 39	102	BR. 266	106	BR. 443	120
BP. 553	83	BP. 5007/S	85	BSB 616	3	BR. 41	101	BR. 277	106	BR. 444	121
BP. 554	83	BP. MADONNA	84	BSB 617/D	98	BR. 42	103	BR. 301	108	BR. 445	124
BP. 555	83			BSB 617/S	98	BR. 43	102	BR. 302	119	BR. 446	122
BP. 556	83			BSB 618/D	98	BR. 44	107	BR. 303	102	BR. 447	114
BP. 557	87			BSB 618/S	98	BR. 45	120	BR. 304	102	BR. 448	115
BP. 558	83			BSB 619/D	98	BR. 46	117	BR. 305	106	BR. 455	124
BP. 559	83			BSB 619/S	98	BR. 47	120	BR. 306	109	BR. 606	125
BP. 560	83			BSB 620	96	BR. 48	117	BR. 307	107	BR. 805	103
BP. 561	83			BSB 621	96	BR. 49	117	BR. 308	117	BR. 807	101
BP. 562	78			BSB 622	96	BR. 51	122	BR. 309	120	BR. 808	108
BP. 563	79			BSB 623	96	BR. 52	125	BR. 311	114	BR. 809	103
BP. 564	81			BSB 624	96	BR. 54	102	BR. 313	108	BR. 810	112
BP. 565	79			BSB 625	96	BR. 56	120	BR. 314	107	BR. 818	121
BP. 566	82			BSB 626	96	BR. 57	119	BR. 315	105	BR. 901	125
BP. 567	89			BSB 627	96	BR. 58	107	BR. 316	112	BR. 902	130
BP. 568	89			BSB 628	96	BR. 59	101	BR. 317	109	BR. 903	127
BP. 569	90			BSB 629	93	BR. 60	109	BR. 318	104	BR. 904	126
BP. 569/D	90			BSB 630	96	BR. 61	112	BR. 322	109	BR. 905	123
BP. 569/S	90			BSB 631	96	BR. 62	102	BR. 323	122	BR. 906	124
BP. 570	81			BSB 632	96	BR. 63	101	BR. 324	104	BR. 907	128
BP. 571	81			BSB 633	97	BR. 64	101	BR. 325	101	BR. 908	129
BP. 572	82			BSB 634	97	BR. 65	103	BR. 327	112	BR. 909	123
BP. 573	82			BSB 635	97	BR. 68	103	BR. 401	107	BR. 910	125
BP. 574	81			BSB 636	97	BR. 69	108	BR. 402	104	BR. 911	119
BP. 578	87			BSB 637	97	BR. 99	120	BR. 403	110	BR. 912	129
BP. 579	93					BR. 101	101	BR. 404	114	BR. 913	113
BP. 580	93					BR. 102	101	BR. 405	102	BR. 914	115
BP. 581	93					BR. 112	113	BR. 407	113	BR. 915	110
BP. 582/D	93					BR. 113	115	BR. 408	110	BR. 917	128
BP. 582/S	93					BR. 115	101	BR. 409	111	BR. 918	130
BP. 583	93					BR. 116	111	BR. 411	109	BR. 920	105
BP. 584	61/84					BR. 119	116	BR. 413	109	BR. 921	108
BP. 585	59/61					BR. 121/L	127	BR. 414	109	BR. 922	123
BP. 586	59/61					BR. 123	106	BR. 415	113	BR. 923	118
BP. 587	87					BR. 124	105	BR. 416	106	BR. 924	118
BP. 588	87					BR. 126	103	BR. 417	105	BR. 925	123
BP. 589	87					BR. 127	119	BR. 418	108	BR. 927	118
BP. 590	87					BR. 146/L	115	BR. 419	108	BR. 928	110
BP. 591	81					BR. 148	107	BR. 420	113	BR. 929	114

# Indice

ROSONI		CERCHI		APPLIQUES		kodos		COPRIGANCI		SUPPORTI	
kodas	puslapis	kodas	puslapis	kodas	puslapis	articulo	puslapis	kodas	puslapis	kodas	puslapis
articulo	pagina	articulo	pagina	articulo	pagina	articulo	pagina	articulo	pagina	articulo	pagina
BR. 930	121	BCE 433	134	BAP 258	140	BBO 821	142	BCG 128	145	BSU 1	150
BR. 931	114	BCE 435	134	BAP 263	140	BBO 3044/A	21	BCG 129	145	BSU 2	150
BR. 932	122	BCE 439	134	BAP 263/D	140	BBO 3044/B	21	BCG 131	145	BSU 3	150
BR. 936	115	BCE 440	134	BAP 263/S	140	BBO 3046/A	21	BCG 132	145	BSU 218	149
BR. 937	106	BCE 817	135	BAP 508	140	BBO 3046/B	21	BCG 133	145	BSU 219	149
BR. 938	112	BCE 832	135	BAP 510	140	BBO 3046/C	21	BCG 139	145	BSU 248	148
BR. 939	106	BCE 842	134	BAP 512	140	BBO 3046/D	21	BCG 142	145	BSU 264	148
BR. 940	118	BCE 843	135			BBO 4000	93/143	BCG 247	145	BSU 501	149
BR. 941	119	BCE 2100	135			BBO 4001	93/143			BSU 502	148
BR. 942	126	BCE 2101	135			BBO 4002	94/143			BSU 503	149
BR. 943	116	BCE 2102	134	<b>BORCHIE</b>		BBO 4003	94/143	<b>SPECCHIERE</b>		BSU 504	149
BR. 944	105	BCE 2103	134	articulo	pagina	BBO 4004	93/143	articulo	pagina	BSU 505	149
PRA 0039	131	BCE 2104	135	BBO 50	142	BBO 4005	59/61/143	BSP 201	147	BSU 511	150
PRA 0052	132	BCE 2105	135	BBO 53	142	BBO 4006	143	BSP 202	147	BSU 513	149
PRC 0039	131	BCE 2106	135	BBO 55	144	BBO 4007	61/143	BSP 245	147	BSU 514	148
PRD 0039	131	BCE 2107	135	BBO 67	143	BBO 4008	60/144	BSP 507	147	BSU 515	66
PRD 0052	132	BCE 2108	134	BBO 71	144	BBO 4009	144	BSP 4500	147	BSU 516	148
PRE 0039	131	BCE 2109	134	BBO 72	144	BBO 4010	84	BSP 4501	147	BSU 517	62
PRE 0052	132	BCE 2110	135	BBO 76	143	BBO 4012	145			BSU 517/C	62
PRG 0039	131	BCE 2111	134	BBO 79	144					BSU 518	150
PRG 0052	132	BCE 2112	134	BBO 82	144					BSU 519	149
PRS 0039	131			BBO 104	143	<b>BOTTOMI</b>				BSU 520	148
PRS 0052	132			BBO 114	144	articulo	pagina			BSU 521	148
				BBO 125	142	BB. 105	142			BSU 522	149
<b>ROSONI</b>		<b>ROSONI COMPONIBILI</b>		BBO 130	143	BB. 106	142			BSU 523	63
<b>PORTAFARETTI</b>		articulo	pagina	BBO 141	144	BB. 107	142			BSU 524	149
articulo	pagina	BCO 319	137	BBO 143	143	BB. 108	142			BSU 525	148
BRF 20000	133	BCO 320	137	BBO 146	143	BB. 109	142			BSU 526	148
		BCO 321	137	BBO 237	143	BB. 110	142			BSU 527	149
		BCO 326	137	BBO 238	143	BB. 111	142			BSU 528	149
		BCO 926	139	BBO 263TG	144	BB. 120	142			BSU 529	148
		BCO 926/A	139	BBO 263TP	144	BB. 326/B	142			BSU 530	148
		BCO 926/B	139	BBO 272/D	84	BB. 351	142			BSU 531	148
		BCO 926/C	139	BBO 272/S	84	BB. 352	142			BSU 532	150
		BCO 926/D	139	BBO 273	144	BB. 436	142			BSU 533	150
		BCO 933	137	BBO 353	144	BB. 437	142			BSU 534	63
		BCO 934	138	BBO 354	142	BB. 443	142			BSU 535	91
		BCO 934/A	138	BBO 355	144	BB. 805	142			BSU 536	91
		BCO 934/B	138	BBO 441	144	BB. 4011	142			BSU 537	148
				BBO 542/T	78	PR. 0008	142			BSU 538	149
				BBO 575	84					BSU 539	150
				BBO 576	84					BSU 3066/C	26
				BBO 577	84					BSU 3074/C	25

Finito di stampare nel mese di Luglio 2008  
presso la Tipografia ABC - Firenze

Progetto grafico  
Giovanni Gheri

Laisvès pr. 82, Vilnius, Lietuva; tel: +37061270035; info@elitedecor.lt; lipdiniai@gmail.com

www.EliteDecor.lt



Italų gamintoji GIPSO LIPDILIŲ „JAGOROVAI“ KAINYNAS 2023-01-01 IKI 2023.06.01



Pastaba: kainos EUR su PVM

Standartinis karnizo ilgis-1,5 metro, išskyrus kataloge pažymėtus ženklų \*, kaina už 1metrą !

DEKORATYVŪS ELEMENTAI/ KAMPAI 31-45,psl						KAMPAI IR CENTRAI 33-45 psl			
KAINA su PVM UŽ VNT						KAINA su PVM UŽ VNT			
Kod. Art.	EUR	Kod. Art.	EUR	Kod. Art.	EUR	Kod. Art.	EUR	Kod. Art.	EUR
BA. 3/A	24,50 €	BA. 270	11,98 €	BA. 828	24,77 €	BA. 888	31,76 €	BAM 205	25,05 €
BA. 6/A	24,41 €	BA. 271	11,98 €	BA. 829	27,41 €	BA. 889	39,11 €	BAM 212	65,61 €
BA. 13/A	24,59 €	BA. 400	31,04 €	BA. 830	31,49 €	BA. 890	46,92 €	BAM 213	24,87 €
BA. 70	29,04 €	BA. 401	8,44 €	BA. 831	35,39 €	BA. 891	45,56 €	BAM 214	65,07 €
BA. 74	42,20 €	BA. 403	32,67 €	BA. 833	65,52 €	BA. 893	67,43 €	BAM 215	30,40 €
BA. 77	25,05 €	BA. 404	9,53 €	BA. 834/S	23,96 €	BA. 894	58,44 €	BAM 216	65,07 €
BA. 81	63,53 €	BA. 405	10,80 €	BA. 835/D	23,96 €	BA. 895	23,50 €	BAM 217	30,31 €
BA. 84	24,87 €	BA. 406	10,71 €	BA. 836	207,09 €	BA. 896	19,60 €	BAM 226	31,85 €
BA. 85	34,39 €	BA. 407	10,71 €	BA. 837	45,10 €	BA. 897	18,69 €	BAM 252	62,44 €
BA. 88	28,77 €	BA. 408	9,53 €	BA. 838	45,47 €	BA. 898	16,34 €	BAM 425	36,03 €
BA. 89	28,68 €	BA. 409	32,94 €	BA. 839	9,53 €	BA. 899	20,33 €	BAM 800	25,86 €
BA. 90	28,86 €	BA. 410	10,71 €	BA. 840	10,80 €	BA. 900	18,33 €	BAM 801	16,52 €
BA. 91	16,24 €	BA. 411	27,32 €	BA. 841	133,22 €	BA. 3066/A	228,69 €	BAM 802	30,58 €
BA. 92	22,96 €	BA. 412	47,19 €	BA. 844	12,25 €	BA. 6000	21,60 €	BAM 860	24,68 €
BA. 93	9,53 €	BA. 413	10,71 €	BA. 845	11,98 €	BA. 6001	19,42 €	BAM 861	37,39 €
BA. 94	10,71 €	BA. 414	10,62 €	BA. 846	11,98 €	BA. 6002	22,42 €	BAM 878	22,60 €
BA. 95	10,71 €	BA. 415	61,62 €	BA. 847	31,49 €	BA. 6003	24,50 €	BAM 880	68,79 €
BA. 96	9,53 €	BA. 417	10,71 €	BA. 848	120,17 €	BA. 6004	58,44 €	BAM 881	22,60 €
BA. 97	10,71 €	BA. 418	12,16 €	BA. 849	11,89 €	BA. 6005	54,18 €	BAM 6008	36,84 €
BA. 98	27,68 €	BA. 419	46,19 €	BA. 851	42,92 €	BA. 6006	40,47 €	BAM 6023	46,55 €
BA. 99	28,59 €	BA. 420	60,80 €	BA. 852	18,60 €	BA. 6007	36,84 €	BAM 6027	48,64 €
BA. 101/L	146,83 €	BA. 421	16,24 €	BA. 853	12,43 €	BA. 6009	21,78 €		
BA. 102/L	134,22 €	BA. 422	47,28 €	BA. 854	9,53 €	BA. 6010	13,79 €		
BA. 118	34,76 €	BA. 423	62,25 €	BA. 855/S	36,03 €	BA. 6011	13,79 €		
BA. 121	9,53 €	BA. 424	35,94 €	BA. 856/D	35,66 €	BA. 6012	9,44 €	DEKORATYVŪS KAMPAI 46.-47.psl.	
BA. 134	41,20 €	BA. 427	25,05 €	BA. 857	25,23 €	BA. 6013	9,53 €	KAINA su PVM UŽ VNT	
BA. 135	41,20 €	BA. 428	61,62 €	BA. 858	29,40 €	BA. 6014	14,52 €	Kod. Art.	EUR
BA. 136	16,24 €	BA. 429	62,16 €	BA. 859	29,40 €	BA. 6015	9,53 €	BAL 73	37,75 €
BA. 137	8,62 €	BA. 430	10,62 €	BA. 862	24,05 €	BA. 6016	18,79 €	BAL 75	48,73 €
BA. 147	25,05 €	BA. 431	24,77 €	BA. 863	24,05 €	BA. 6017	7,08 €	BAL 78	20,33 €
BA. 206	30,95 €	BA. 432	27,04 €	BA. 865	11,62 €	BA. 6018	9,44 €	BAL 83	63,25 €
BA. 220	24,68 €	BA. 434	55,72 €	BA. 866	11,62 €	BA. 6019	13,07 €	BAL 100	27,13 €
BA. 222	10,16 €	BA. 441	25,32 €	BA. 867	24,87 €	BA. 6020	18,51 €	BAL 103	16,34 €
BA. 223	10,80 €	BA. 442	24,68 €	BA. 868	24,87 €	BA. 6021	13,79 €	BAL 144	54,81 €
BA. 225	24,77 €	BA. 443	9,53 €	BA. 869	24,77 €	BA. 6024	46,19 €	BAL 145	24,41 €
BA. 229	11,98 €	BA. 804	9,53 €	BA. 870	12,25 €	BA. 6025	46,28 €	BAL 224	39,66 €
BA. 230	10,62 €	BA. 806	16,24 €	BA. 871	10,71 €	BA. 6026	46,01 €	BAL 227	54,18 €
BA. 231	10,80 €	BA. 811	62,25 €	BA. 872	24,96 €			BAL 228	39,66 €
BA. 232	10,71 €	BA. 812	21,24 €	BA. 873	137,38 €			BAL 249	33,58 €
BA. 233	10,71 €	BA. 813	11,98 €	BA. 874	135,20 €			BAL 426	27,04 €
BA. 234	9,53 €	BA. 814	55,59 €	BA. 875	16,52 €			BAL 850	35,57 €
BA. 235	12,07 €	BA. 815	62,89 €	BA. 876	12,71 €			BAL 864	101,46 €
BA. 246	11,98 €	BA. 816	11,98 €	BA. 877	27,04 €			BAL 892	103,09 €
BA. 251	62,44 €	BA. 819	10,62 €	BA. 879	15,52 €			BAL 6022	101,46 €
BA. 257	19,15 €	BA. 820	10,25 €	BA. 882/D	19,51 €				
BA. 259	30,67 €	BA. 822	24,32 €	BA. 882/S	19,51 €				
BA. 260	28,77 €	BA. 823	25,05 €	BA. 883	43,65 €				
BA. 261	28,77 €	BA. 824	24,41 €	BA. 884	69,15 €				
BA. 267	10,71 €	BA. 825	10,71 €	BA. 885	69,06 €				
BA. 268	10,71 €	BA. 826	24,96 €	BA. 886	22,32 €				
BA. 269	9,53 €	BA. 827	24,68 €	BA. 887	24,05 €				

UAB KUBĖ; Laisvės pr. 82 Vilnius

Tel: +37061270035; info@elitedecor.lt

www.EliteDecor.lt

ROZETĖS 142.-145.psl.		ROZETĖS MAŽOS 142.-144.psl.		KOLONOS IR PILIASTRAI 55-56.psl.		KOLONOS IR PILIASTRAI 55-56.psl.			
KAINA su PVM UŽ VNT		KAINA su PVM UŽ VNT		KAINA su PVM UŽ M		KAINA su PVM UŽ VNT		KAINA su PVM UŽ VNT	
Kod. Art.	EUR	Kod. Art.	EUR	Kod. Art.	EUR	Kod. Art.	EUR	Kod. Art.	EUR
BBO 50	19,51 €	BB. 105	4,17 €	BCR 4	23,96 €	BCR 2003/B	457,02 €	BCR 2027/CDOR	203,64 €
BBO 53	19,69 €	BB. 106	4,17 €	BCR 5	26,59 €	BCR 2004	380,51 €	BCR 2027/CM	183,59 €
BBO 55	19,69 €	BB. 107	4,17 €	BCR 6	34,21 €	BCR 2004/B	335,23 €	BCR 2027/CMDOR	169,97 €
BBO 67	15,70 €	BB. 108	4,17 €	BCR 6/B	50,09 €	BCR 2004/C	335,23 €	BCR 2030/B	37,48 €
BBO 71	11,25 €	BB. 109	4,17 €	BCR 7	24,77 €	BCR 2006	15,61 €	BCR 2030/B1	20,69 €
BBO 72	14,88 €	BB. 110	4,17 €	BCR 2005	43,74 €	BCR 2007	15,88 €	BCR 2030/C	44,38 €
BBO 76	11,07 €	BB. 111	4,17 €	BCR 2016	47,10 €	BCR 2008	17,88 €	BCR 2030/C1	23,14 €
BBO 79	11,25 €	BB. 120	4,99 €	BCR 2017	39,57 €	BCR 2009	25,05 €	BCR 2030/T	19,06 €
BBO 82	14,79 €	BB. 326/B	3,09 €	BCR 2020	39,39 €	BCR 2010	30,40 €		
BBO 104	10,35 €	BB. 351	5,35 €	BCR 2021	67,88 €	BCR 2011	786,53 €		
BBO 114	19,42 €	BB. 352	5,35 €	BCR 2022	39,93 €	BCR 2015	918,66 €		
BBO 125	19,42 €	BB. 436	10,71 €	BCR 2024	41,65 €	BCR 2016/B	80,50 €		
BBO 130	19,51 €	BB. 437	9,98 €	BCR 2025	61,98 €	BCR 2016/C	62,53 €		
BBO 141	14,70 €	BB. 443	4,17 €	BCR 2026	82,55 €	BCR 2017/B	20,24 €		
BBO 143	14,70 €	BB. 805	5,35 €	BCR 2027	112,38 €	BCR 2017/C	19,42 €		
BBO 146	10,25 €	BB. 4011	4,17 €	BCR 2028	105,46 €	BCR 2018	11,62 €		
BBO 237	19,51 €	PR. 0008	3,99 €	BCR 2029	83,20 €	BCR 2019	11,89 €		
BBO 238	19,51 €			BCR 2030	45,47 €	BCR 2020/B	63,34 €		
BBO 263TG.	26,59 €					BCR 2020/C	31,67 €		
BBO 263TP.	24,14 €					BCR 2020/T	12,98 €		
BBO 272/D	11,71 €	LUBŲ APDAILA IR PANELĖS 77.psl				BCR 2021/B	80,22 €		
BBO 272/S	11,71 €	KAINA su PVM UŽ VNT				BCR 2021/C	58,72 €		
BBO 273	14,88 €	Kod. Art.	EUR			BCR 2021/T	24,32 €		
BBO 353	14,88 €	BCA 62/B	57,35 €			BCR 2022/B	22,05 €		
BBO 354	14,52 €	BCA 650	52,54 €			BCR 2022/C	21,60 €		
BBO 355	15,16 €	BCA 803	54,00 €			BCR 2023	8,26 €		
BBO 441	15,16 €	BCA 6600	57,72 €			BCR 2023/D	44,83 €		
BBO 542/T	51,55 €			KOLONOS IR PILIASTRAI 56-57.psl.		BCR 2023/S	44,83 €	APDAILOS ELEMENTAI 140 psl.	
BBO 575	35,57 €			KAINA su PVM UŽ VNT		BCR 2024/B	59,26 €	KAINA su PVM UŽ VNT	
BBO 576	35,57 €			Kod. Art.	EUR	BCR 2024/BM	43,11 €	Kod. Art.	EUR
BBO 577	45,10 €			BCR 4/A	6,72 €	BCR 2024/C	92,47 €	BAP 258	98,83 €
BBO 821	5,45 €	DEKORAI LUBOMS 137.-140.psl		BCR 5/A	6,99 €	BCR 2024/CDOR	55,90 €	BAP 263	126,23 €
BBO 3044/A	25,50 €	KAINA su PVM UŽ VNT		BCR 7/A	17,70 €	BCR 2024/CM	63,34 €	BAP 263/D	40,20 €
BBO 3044/B	25,05 €	Kod. Art.	EUR	BCR 8	13,61 €	BCR 2024/CMDOR	34,49 €	BAP 263/S	40,20 €
BBO 3046/A	15,25 €	BCO 319	33,03 €	BCR 9	13,70 €	BCR 2025/A	3,27 €	BAP 263/S	40,20 €
BBO 3046/B	18,15 €	BCO 320	33,76 €	BCR 11	311,36 €	BCR 2025/B	142,57 €	BAP 508	81,95 €
BBO 3046/C	23,96 €	BCO 321	33,76 €	BCR 11/B	296,57 €	BCR 2025/BM	99,92 €	BAP 510	76,50 €
BBO 3046/D	21,78 €	BCO 326	76,23 €	BCR 11/BA	132,68 €	BCR 2025/C	196,93 €	BAP 512	98,83 €
BBO 4000	5,81 €	BCO 926	774,91 €	BCR 12	15,25 €	BCR 2025/CDOR	148,56 €		
BBO 4001	5,72 €	BCO 926/A	47,46 €	BCR 13	15,52 €	BCR 2025/CM	123,69 €		
BBO 4002	5,99 €	BCO 926/B	90,75 €	BCR 14	27,95 €	BCR 2025/CMDOR	75,59 €		
BBO 4003	5,72 €	BCO 926/C	81,77 €	BCR 15	28,50 €	BCR 2025/D	5,72 €		
BBO 4004	6,17 €	BCO 926/D	65,61 €	BCR 16	258,91 €	BCR 2026/B	204,10 €		
BBO 4005	5,63 €	BCO 933	27,50 €	BCR 16/B	201,56 €	BCR 2026/BM	104,08 €		
BBO 4006	5,72 €	BCO 934	554,03 €	BCR 17	234,68 €	BCR 2026/C	233,86 €		
BBO 4007	5,72 €	BCO 934/A	67,70 €	BCR 18	114,80 €	BCR 2026/CDOR	186,67 €		
BBO 4008	6,26 €	BCO 934/B	32,85 €	BCR 2001/D	123,51 €	BCR 2026/CM	112,17 €		
BBO 4009	15,34 €			BCR 2001/S	123,51 €	BCR 2026/CMDOR	100,56 €		
BBO 4010	45,10 €			BCR 2002	85,67 €	BCR 2027/B	297,04 €	UAB KUBĖ; Laisvės pr. 82 Vilnius	
BBO 4012	13,34 €			BCR 2003	619,37 €	BCR 2027/BM	155,25 €	Tel: +37061270035; info@elitedecor.lt	
						BCR 2027/C	321,98 €	www.EliteDecor.lt	





KAMPINIAI KARNIZAI 18-27psl.				BAROKO STILIAUS DEKORAI LUBOMS 95-98.psl.		APDAILA ŽIDINIAMS 71.-74.psl.		NAUJI KARNIZAI LED APŠVIETIMUI	
KAINA su PVM UŽ M				KAINA su PVM UŽ VNT		KAINA su PVM UŽ VNT		KAINA su PVM UŽ VNT	
Kod. Art.	EUR	Kod. Art.	EUR	Kod. Art.	EUR	Kod. Art.	EUR	Kod. Art.	EUR
BS. 8/S	69,04 €	BS. 785	25,81 €	BSB 600	104,93 €	BRC 651/C	952,28 €	LED 1	56,75
BS. 9/S	68,44 €	BS. 799	21,45 €	BSB 601/D	22,38 €	BRC 652/C	683,84 €	LED 2	27,39
BS. 201	11,16 €	BS. 3000	18,35 €	BSB 601/S	22,38 €	BRC 653/C	644,69 €	LED 3	25,92
BS. 202	11,38 €	BS. 3014	19,93 €	BSB 602/D	26,30 €	BRC 654/C	683,84 €	LED 4	26,55
BS. 203	6,21 €	BS. 3015	15,79 €	BSB 602/S	26,19 €	BRC 655/C	670,44 €	LED 5	34,36
BS. 204	11,27 €	BS. 3023	17,21 €	BSB 603/D	33,16 €	BRC 656/C	685,85 €	LED 6	66,50
BS. 294	42,09 €	BS. 3026	58,75 €	BSB 603/S	33,21 €	BRC 657/C	904,14 €	LED 7	14,09
BS. 295	28,64 €	BS. 3027	11,43 €	BSB 604	19,44 €			LED 8	10,66
BS. 295/B	18,02 €	BS. 3028	14,76 €	BSB 605/D	26,08 €				
BS. 297	42,47 €	BS. 3031	18,79 €	BSB 605/S	26,08 €	KARNIZAI 16.psl.		KAMPAI LED KARNIZAMS	
BS. 298	21,07 €	BS. 3033	57,61 €	BSB 607	77,43 €	KAINA su PVM UŽ M		KAINA su PVM UŽ VNT	
BS. 298/B	12,58 €	BS. 3034	59,13 €	BSB 608	31,64 €	Kod. Art.	EUR	Kod. Art.	EUR
BS. 710	28,53 €	BS. 3039	18,51 €	BSB 609	39,59 €	PENS 5	9,15 €	LED 1/A	38,03
BS. 711	20,80 €	BS. 3044	29,40 €	BSB 610	73,51 €	PENS 10	17,64 €	LED 1/B	25,21
BS. 712	28,59 €	BS. 3046	44,32 €	BSB 611	30,33 €	PENS 14	21,83 €	LED 2/A	26,44
BS. 713	31,04 €	BS. 3047	61,26 €	BSB 612	31,64 €	PENS 18	30,66 €	LED 2/B	19,43
BS. 714	26,79 €	BS. 3048	45,74 €	BSB 613	36,54 €	KARNIZAI/ MANTOVANE 28.psl.			
BS. 715/S	16,23 €	BS. 3049	8,66 €	BSB 614	50,42 €	KAINA su PVM UŽ M			
BS. 716	25,48 €	BS. 3050	10,24 €	BSB 615	83,74 €	Kod. Art.	EUR		
BS. 717	12,14 €	BS. 3052	24,72 €	BSB 616	9,31 €	BMAN 8	25,59 €		
BS. 718	18,35 €	BS. 3054	18,79 €	BSB 617/D	79,77 €	BMAN 10	26,24 €		
BS. 719	18,62 €	BS. 3055	19,71 €	BSB 617/S	79,77 €	BMAN 12	30,55 €		
BS. 725	9,75 €	BS. 3056	19,60 €	BSB 618/D	29,89 €	BMAN 14	31,20 €		
BS. 728	86,09 €	BS. 3057	22,81 €	BSB 618/S	29,89 €	BMAN 16	36,10 €		
BS. 729	87,77 €	BS. 3059	50,48 €	BSB 619/D	24,12 €	BMAN 18	43,18 €		
BS. 730	47,04 €	BS. 3062	42,36 €	BSB 619/S	24,12 €	BMAN 20	48,46 €		
BS. 731	70,02 €	BS. 3063	360,30 €	BSB 620	14,65 €	KARNIZAI IŠLENKTAIS KAMPAIS 27.psl.			
BS. 733	43,78 €	BS. 3064	117,78 €	BSB 621	15,90 €	KAINA su PVM UŽ M			
BS. 734	8,88 €	BS. 3065	145,87 €	BSB 622	22,00 €	Kod. Art.	EUR		
BS. 736	176,47 €	BS. 3066	136,18 €	BSB 623	18,19 €	BG. 3	7,68 €		
BS. 739	69,31 €	BS. 3067	121,91 €	BSB 624	21,94 €	BG. 5	13,78 €		
BS. 741	12,41 €	BS. 3070	68,23 €	BSB 625	28,70 €	BG. 7	17,48 €		
BS. 742	12,31 €	BS. 3071	69,70 €	BSB 626	9,37 €	BG. 10	27,88 €		
BS. 743	27,77 €	BS. 3072	49,55 €	BSB 627	17,37 €	BG. 15	34,47 €		
BS. 744	33,98 €	BS. 3073	50,15 €	BSB 628	9,86 €	BG. 20	57,83 €		
BS. 745	18,19 €	BS. 3074	83,80 €	BSB 629	21,07 €	ROZETĖS 139 psl			
BS. 746	9,15 €	BS. 3075	82,22 €	BSB 630	16,93 €	KAINA su PVM UŽ VNT			
BS. 751	46,23 €	BS. 3076	82,22 €	BSB 631	32,07 €	Kod. Art.	EUR		
BS. 755	17,91 €			BSB 632	18,89 €	BCG 128	15,34 €		
BS. 756	15,84 €			BSB 633	20,31 €	BCG 129	15,43 €		
BS. 757	15,19 €	PCA 0200	26,50 €	BSB 634	12,31 €	BCG 131	15,34 €		
BS. 760	29,62 €	PCD 0200	27,32 €	BSB 635	60,77 €	BCG 132	23,23 €		
BS. 761	15,19 €	PCE 0200	26,50 €	BSB 636	44,38 €	BCG 133	19,51 €		
BS. 762	18,19 €	PCG 0200	26,14 €	BSB 637	58,37 €	BCG 139	19,51 €		
BS. 764	43,61 €	PCS 0200	26,50 €			BCG 142	19,33 €		
BS. 765	43,78 €					BCG 247	40,66 €		
BS. 769	13,07 €								
BS. 770	11,87 €								
BS. 773	28,80 €								
BS. 781	58,37 €								
BS. 783	28,31 €								

UAB KUBĖ; Laisvės pr. 82 Vilnius  
Tel: +37061270035; info@elitedecor.lt  
[www.EliteDecor.lt](http://www.EliteDecor.lt)



## LUBŲ ROZETĖS 101-133.psl.

## KAINA su PVM UŽ VNT

Kod. Art.	EUR	Kod. Art.	EUR	Kod. Art.	EUR	Kod. Art.	EUR	Kod. Art.	EUR
BR. 20	76,96 €	BR. 119	54,09 €	BR. 403	42,38 €	BR. 905	95,22 €	PRA 0039	47,10 €
BR. 21	76,87 €	BR. 121/L	197,93 €	BR. 404	28,77 €	BR. 906	110,15 €	PRA 0052	57,72 €
BR. 22	55,45 €	BR. 123	42,11 €	BR. 405	24,96 €	BR. 907	432,61 €	PRC 0039	47,64 €
BR. 23	49,82 €	BR. 124	42,20 €	BR. 407	45,83 €	BR. 908	278,78 €	PRD 0039	47,01 €
BR. 24	44,47 €	BR. 126	41,56 €	BR. 408	46,74 €	BR. 909	101,37 €	PRD 0052	57,26 €
BR. 25	47,64 €	BR. 127	45,83 €	BR. 409	46,83 €	BR. 910	375,27 €	PRE 0039	47,28 €
BR. 26	47,64 €	BR. 146/L	54,54 €	BR. 411	46,01 €	BR. 911	75,87 €	PRE 0052	57,72 €
BR. 27	47,55 €	BR. 148	42,82 €	BR. 413	46,55 €	BR. 912	461,46 €	PRG 0039	48,46 €
BR. 28	47,55 €	BR. 149	47,83 €	BR. 414	47,55 €	BR. 913	49,91 €	PRG 0052	58,26 €
BR. 29	46,01 €	BR. 150	28,77 €	BR. 415	68,33 €	BR. 914	49,91 €	PRS 0039	47,10 €
BR. 30	42,56 €	BR. 151	72,60 €	BR. 416	45,92 €	BR. 915	47,10 €	PRS 0052	57,54 €
BR. 32	42,74 €	BR. 152	67,34 €	BR. 417	42,29 €	BR. 917	420,81 €		
BR. 33	42,02 €	BR. 153	46,37 €	BR. 418	46,37 €	BR. 918	544,68 €		
BR. 34	42,38 €	BR. 154	46,92 €	BR. 419	45,65 €	BR. 920	44,01 €		
BR. 35	28,77 €	BR. 155	48,10 €	BR. 420	45,65 €	BR. 921	44,83 €		
BR. 36	45,83 €	BR. 156	46,46 €	BR. 421	49,28 €	BR. 922	91,89 €		
BR. 37	28,13 €	BR. 157	27,86 €	BR. 422	48,46 €	BR. 923	78,50 €	LUBŲ ROZETĖS SU ŠVIESOS DIFUZORIAIS 133 psl.	
BR. 38	46,19 €	BR. 158	28,95 €	BR. 423	48,91 €	BR. 924	76,01 €	KAINA su PVM UŽ VNT	
BR. 39	28,77 €	BR. 159	28,77 €	BR. 425	48,28 €	BR. 925	84,31 €	Kod. Art.	EUR
BR. 41	28,40 €	BR. 160	52,09 €	BR. 427	43,56 €	BR. 927	60,35 €	BRF 20000	572,00 €
BR. 42	42,38 €	BR. 161	28,40 €	BR. 428	47,64 €	BR. 928	46,83 €		
BR. 43	28,68 €	BR. 207	105,00 €	BR. 429	49,73 €	BR. 929	48,73 €		
BR. 44	45,47 €	BR. 241	198,11 €	BR. 430	47,55 €	BR. 930	74,85 €		
BR. 45	47,64 €	BR. 242	75,58 €	BR. 431	75,59 €	BR. 931	48,19 €		
BR. 46	47,64 €	BR. 243	75,87 €	BR. 432	42,56 €	BR. 932	82,66 €		
BR. 47	48,73 €	BR. 244	107,27 €	BR. 433	42,02 €	BR. 936	160,17 €		
BR. 48	67,97 €	BR. 266	42,02 €	BR. 434	53,81 €	BR. 937	47,73 €		
BR. 49	62,53 €	BR. 277	29,68 €	BR. 435	53,81 €	BR. 938	57,63 €		
BR. 51	74,51 €	BR. 301	46,01 €	BR. 436	64,61 €	BR. 939	37,57 €		
BR. 52	99,83 €	BR. 302	57,35 €	BR. 437	78,59 €	BR. 940	72,06 €		
BR. 54	28,40 €	BR. 303	28,40 €	BR. 438	75,50 €	BR. 941	81,13 €		
BR. 56	46,74 €	BR. 304	29,13 €	BR. 439	28,22 €	BR. 942	145,13 €		
BR. 57	129,95 €	BR. 305	29,13 €	BR. 440	24,68 €	BR. 943	110,62 €		
BR. 58	42,11 €	BR. 306	46,74 €	BR. 443	91,84 €	BR. 944	50,18 €		
BR. 59	41,02 €	BR. 307	62,80 €	BR. 444	80,08 €				
BR. 60	27,95 €	BR. 308	64,52 €	BR. 445	94,20 €				
BR. 61	28,22 €	BR. 309	46,74 €	BR. 446	76,96 €				
BR. 62	28,31 €	BR. 311	47,28 €	BR. 447	28,31 €				
BR. 63	27,68 €	BR. 313	46,01 €	BR. 448	48,64 €				
BR. 64	28,13 €	BR. 314	45,65 €	BR. 455	107,09 €				
BR. 65	41,65 €	BR. 315	67,25 €	BR. 606	200,56 €				
BR. 68	42,47 €	BR. 316	42,38 €	BR. 805	29,04 €				
BR. 69	45,83 €	BR. 317	46,55 €	BR. 807	24,04 €				
BR. 95	53,81 €	BR. 318	45,65 €	BR. 808	45,83 €				
BR. 99	45,83 €	BR. 322	47,10 €	BR. 809	42,38 €				
BR. 101	28,22 €	BR. 323	74,42 €	BR. 810	48,46 €				
BR. 102	22,14 €	BR. 324	42,02 €	BR. 818	99,46 €				
BR. 112	49,91 €	BR. 325	28,40 €	BR. 901	169,97 €				
BR. 113	56,36 €	BR. 327	62,07 €	BR. 902	587,06 €			UAB KUBĖ; Laisvės pr. 82 Vilnius	
BR. 115	19,88 €	BR. 401	43,29 €	BR. 903	219,80 €			Tel: +37061270035; info@elitedecor.lt	
BR. 116	63,16 €	BR. 402	42,47 €	BR. 904	167,55 €			<a href="http://www.EliteDecor.lt">www.EliteDecor.lt</a>	

